

WHELEN[®]

ENGINEERING COMPANY INC.

51 Winthrop Road
Chester, Connecticut 06412-0684
Phone: (860) 526-9504
Internet: www.whelen.com
Sales e-mail: autosale@whelen.com
Customer Service e-mail: custserv@whelen.com

Installation Guide:
Inner Edge[®] XLP WeCan[®] DUO+[™] Lightbar
(6 & 12 Light)

Warnings to Installers

Whelen's emergency vehicle warning devices must be properly mounted and wired in order to be effective and safe. Read and follow all of Whelen's written instructions when installing or using this device. Emergency vehicles are often operated under high speed stressful conditions which must be accounted for when installing all emergency warning devices. Controls should be placed within convenient reach of the operator so that they can operate the system without taking their eyes off the roadway. Emergency warning devices can require high electrical voltages and/or currents. Properly protect and use caution around live electrical connections. Grounding or shorting of electrical connections can cause high current arcing, which can cause personal injury and/or vehicle damage, including fire. Many electronic devices used in emergency vehicles can create or be affected by electromagnetic interference. Therefore, after installation of any electronic device it is necessary to test all electronic equipment simultaneously to insure that they operate free of interference from other components within the vehicle. Never power emergency warning equipment from the same circuit or share the same grounding circuit with radio communication equipment. All devices should be mounted in accordance with the manufacturer's instructions and securely fastened to vehicle elements of sufficient strength to withstand the forces applied to the device. Driver and/or passenger air bags (SRS) will affect the way equipment should be mounted. This device should be mounted by permanent installation and within the zones specified by the vehicle manufacturer, if any. Any device mounted in the deployment area of an air bag will damage or reduce the effectiveness of the air bag and may damage or dislodge the device. Installer must be sure that this device, its mounting hardware and electrical supply wiring does not interfere with the air bag or the SRS wiring or sensors. Mounting the unit inside the vehicle by a method other than permanent installation is not recommended as unit may become dislodged during swerving; sudden braking or collision. Failure to follow instructions can result in personal injury. Whelen assumes no liability for any loss resulting from the use of this warning device. **PROPER INSTALLATION COMBINED WITH OPERATOR TRAINING IN THE PROPER USE OF EMERGENCY WARNING DEVICES IS ESSENTIAL TO INSURE THE SAFETY OF EMERGENCY PERSONNEL AND THE PUBLIC.**

Warnings to Users

Whelen's emergency vehicle warning devices are intended to alert other operators and pedestrians to the presence and operation of emergency vehicles and personnel. However, the use of this or any other Whelen emergency warning device does not guarantee that you will have the right-of-way or that other drivers and pedestrians will properly heed an emergency warning signal. Never assume you have the right-of-way. It is your responsibility to proceed safely before entering an intersection, driving against traffic, responding at a high rate of speed, or walking on or around traffic lanes. Emergency vehicle warning devices should be tested on a daily basis to ensure that they operate properly. When in actual use, the operator must ensure that both visual and audible warnings are not blocked by vehicle components (i.e.: open trunks or compartment doors), people, vehicles, or other obstructions. It is the user's responsibility to understand and obey all laws regarding emergency warning devices. The user should be familiar with all applicable laws and regulations prior to the use of any emergency vehicle warning device. Whelen's audible warning devices are designed to project sound in a forward direction away from the vehicle occupants. However, because sustained periodic exposure to loud sounds can cause hearing loss, all audible warning devices should be installed and operated in accordance with the standards established by the National Fire Protection Association.

Safety First

This document provides all the necessary information to allow your Whelen product to be properly and safely installed. Before beginning the installation and/or operation of your new product, the installation technician and operator must read this manual completely. Important information is contained herein that could prevent serious injury or damage.

⚠ WARNING: This product can expose you to chemicals including Lead which is known to the State of California to cause cancer and birth defects or other reproductive harm. For more information go to www.P65Warnings.ca.gov.

- **Proper installation of this product requires the installer to have a good understanding of automotive electronics, systems and procedures.**
- **Whelen Engineering requires the use of waterproof butt splices and/or connectors if that connector could be exposed to moisture.**
- **Any holes, either created or utilized by this product, should be made both air- and watertight using a sealant recommended by your vehicle manufacturer.**
- **Failure to use specified installation parts and/or hardware will void the product warranty.**
- **If mounting this product requires drilling holes, the installer MUST be sure that no vehicle components or other vital parts could be damaged by the drilling process. Check both sides of the mounting surface before drilling begins. Also de-burr the holes and remove any metal shards or remnants. Install grommets into all wire passage holes.**
- **If this manual states that this product may be mounted with suction cups, magnets, tape or Velcro[®], clean the mounting surface with a 50/50 mix of isopropyl alcohol and water and dry thoroughly.**
- **Do not install this product or route any wires in the deployment area of your air bag. Equipment mounted or located in the air bag deployment area will damage or reduce the effectiveness of the air bag, or become a projectile that could cause serious personal injury or death. Refer to your vehicle owner's manual for the air bag deployment area. The User/Installer assumes full responsibility to determine proper mounting location, based on providing ultimate safety to all passengers inside the vehicle.**
- **For this product to operate at optimum efficiency, a good electrical connection to chassis ground must be made. The recommended procedure requires the product ground wire to be connected directly to the NEGATIVE (-) battery post (this does not include products that use cigar power cords).**
- **If this product uses a remote device for activation or control, make sure that this device is located in an area that allows both the vehicle and the device to be operated safely in any driving condition.**
- **Do not attempt to activate or control this device in a hazardous driving situation.**
- **This product contains either strobe light(s), halogen light(s), high-intensity LEDs or a combination of these lights. Do not stare directly into these lights. Momentary blindness and/or eye damage could result.**
- **Use only soap and water to clean the outer lens. Use of other chemicals could result in premature lens cracking (crazing) and discoloration. Lenses in this condition have significantly reduced effectiveness and should be replaced immediately. Inspect and operate this product regularly to confirm its proper operation and mounting condition. Do not use a pressure washer to clean this product.**
- **It is recommended that these instructions be stored in a safe place and referred to when performing maintenance and/or reinstallation of this product.**
- **FAILURE TO FOLLOW THESE SAFETY PRECAUTIONS AND INSTRUCTIONS COULD RESULT IN DAMAGE TO THE PRODUCT OR VEHICLE AND/OR SERIOUS INJURY TO YOU AND YOUR PASSENGERS!**

IMPORTANT! The lightbar should be located a minimum of 16" from any radio antennas!

Note: When routing the wires, it is important to choose a path that will keep the wires away from excessive heat or any vehicle equipment that could compromise the integrity of the wires (ex. trunk lids, door jams, etc.)

Installation:

1. Using a screwdriver, loosen (*do not remove*) the three screws securing the passenger-side **visor swivel** bracket to the vehicle.
2. Remove the screws securing the **visor clip** to the vehicle. Remove and retain the clip and all hardware (**See reference to retainer below**).
3. Secure the bracket to the Inner Edge housing using the two supplied #8-32 X 3/8 Torx Head Screws.
4. Position the keyed opening of the mounting bracket directly under the mounting location for the **visor clip** and remount the **visor clip** in its original location using the original hardware (Fig. 1).
5. Firmly tighten any hardware loosened in this procedure.
6. Repeat Steps 1 through 5 for the driver-side assembly.
7. When properly mounted, the rubber seal will be in full contact with the vehicle windshield and roof. This is to prevent light output from entering the passenger compartment. When this has been achieved, tighten mounting hardware firmly to maintain contact (Fig. 1).
8. Route the lightbar cable down the vehicle A-pillar to your control head.
9. Make all wiring connections using the information in the wiring diagram.

The Tahoe and Silverado have a retainer which holds the headliner to the visor clip that must be replaced with the supplied spacer.

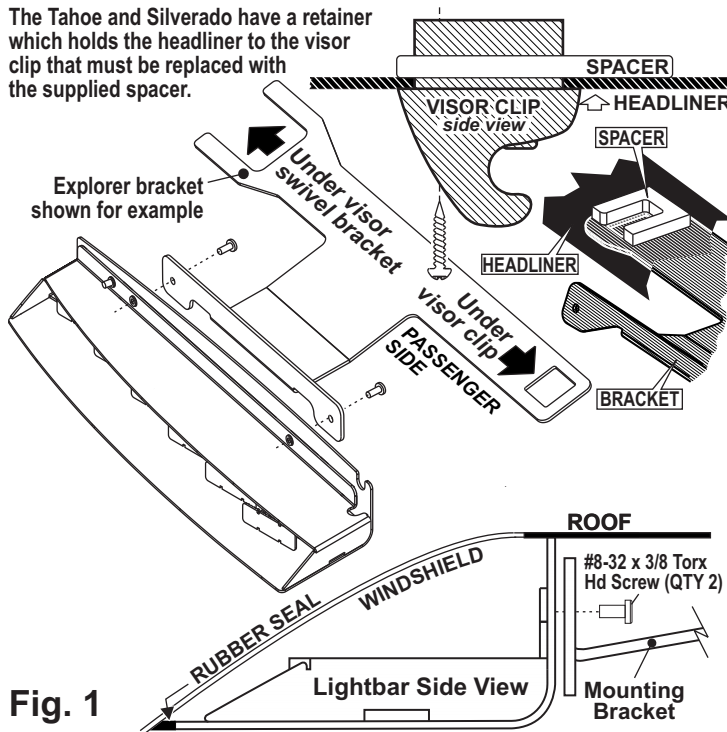

Fig. 1

Connecting the Power Cable:

WARNING! All customer supplied wires that connect to the positive terminal of the battery must be sized to supply at least 125% of the maximum operating current and **FUSED** at the battery to carry that load. **DO NOT USE CIRCUIT BREAKERS WITH THIS PRODUCT!**

1. Follow the factory wiring harness through the fire wall. It may be necessary to drill a hole in the fire wall. If so, be absolutely sure that there are no components that could be damaged by drilling. After the hole has been drilled, insert a grommet to protect the cable.
2. Route the cable along the factory wiring harness towards the battery. Install a 40 amp fuse block (customer supplied) on the end of the RED wire in the power cable. **NOTE: Remove the fuse from the fuse block before connecting any wires to the battery.**
3. Connect the BLACK wire to Chassis Ground.

Connecting the Communication Cable:

Splice the GREEN and GREY wires from the lightbar to the GREEN and GREY wires from the Whelen WC Controller.

Control Point Module

The Control Point Module serves as the brain of the Whelen WC Series lightbar. The module is programmed with the WeCan™ Programming Software via the USB port and in turn, provides the necessary signals that allow the lightbar to function as desired.

In the WeCan™ Programming software, each of the 18 inputs may be programmed to activate any number or combination of the installed lightbar components by applying +12VDC to an input. Refer to the installation guide included with your switches for wiring information.

Programming Procedure -

IMPORTANT - It is not necessary to program this device unless changes to the default configuration (for example pattern or switch control changes) are desired.

1. Connect a USB cable from the host PC to the module's USB port.
2. Start the **WeCan™** software on the host PC and open the configuration to be programmed.
3. Click on the **WeCan** button on the menu bar. Select **Control Point** then **Program** from the fly-out.
4. A window will open to confirm that you are about to program a Control Point Module. Confirm that the USB cable is connected to both the module and the PC and then press "OK" to continue. The software will display a window when the programming procedure has been successfully completed.
5. Confirm proper operation of the module. Your lightbar should now be fully operational.

DEFAULT CONFIGURATION (12V Inputs)

POS	COLOR	FUNCTION
1	GREEN	ALTERNATING DRIVER-PASSENGER (SignalAlert™ 75)
2	GRN/WHT	ALTERNATING SIDE-TO-SIDE (SignalAlert™ 75)
3	GRN/BLK	IN-OUT (SignalAlert™ 75)
4	WHT/RED	ALTERNATING DRIVER-PASSENGER (ASYNC) (SignalAlert™ 75)
5	WHITE	DRIVER OUTBOARD DUO (STEADY)
6	YELLOW	PASSENGER OUTBOARD DUO (STEADY)
7	WHT/VIO	DRIVER INBOARD (CA STEADY)
8	WHT/GRN*	OUTBOARD DUO (SingleFlash 150)
9	WHT/ORG	CRUISE LIGHTS
10	BLUE	CA BAR PATTERN
11	BLU/WHT	ULTRA SCAN BAR PATTERN
12	BLU/BLK	CA SINGLE ULTRA SCAN BAR PATTERN
13	WHT/BRN	ZZ CA 75 BAR PATTERN
14	WHT/BLK	CENTER DUO (STEADY)
15	WHT/BLU	ALTERNATING SIDE-TO-SIDE DUO (DoubleFlash 75)
16	RED/WHT	ALL DUO (STEADY)
17	WHT/YEL*	CENTER DUO (SingleFlash 150)
18	VIOLET	LOW POWER

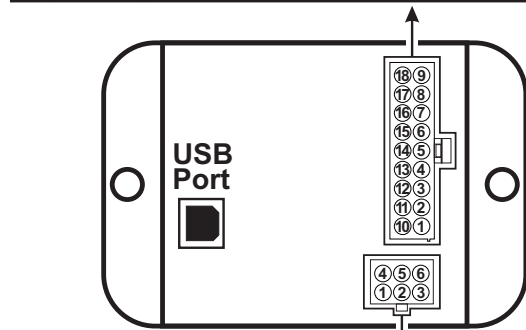

POS	COLOR	FUNCTION
1	RED ¹	+12VDC
2	None	
3	BLACK	GROUND
4	GREEN ²	COMM. A
5	BLK/WHT ²	SHIELD
6	GREY ²	COMM. B

¹ Connect to an ignition controlled circuit that can accommodate an additional 250mA load.

² from lightbar

**Installation 2019 - 2020 Dodge Ram 1500:
Inner Edge XLP**

Screw (Fig. 1). Loosely mount the bracket to the vehicle then pull the bracket as far back from the windshield as it goes (Fig. 3). With the bracket in place tighten the mounting hardware.

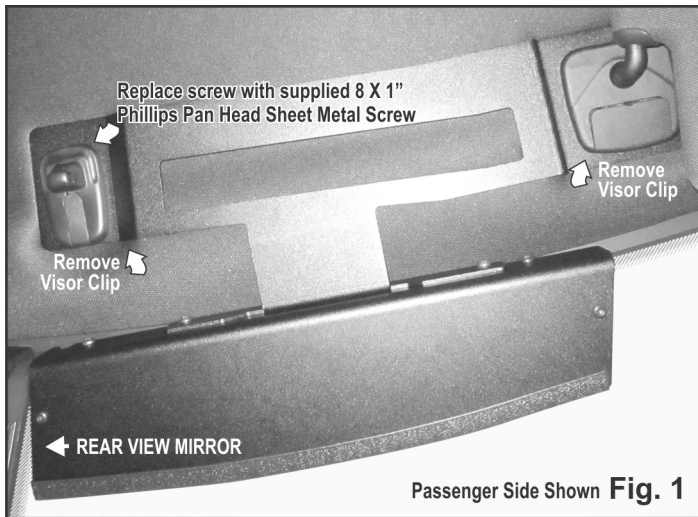

1. Remove the vehicle Visor Clips. The bracket will sit under these clips after mounting (Fig. 1).
2. Mount the bracket to the light array as shown so the mounting hardware sits at the top of the mounting slot on the bracket (Fig. 2). Tighten hardware firmly.
3. Replace the vehicle clip mounting screw near the rear view mirror with the supplied 8 X 1" Phillips Pan Head Sheet Metal

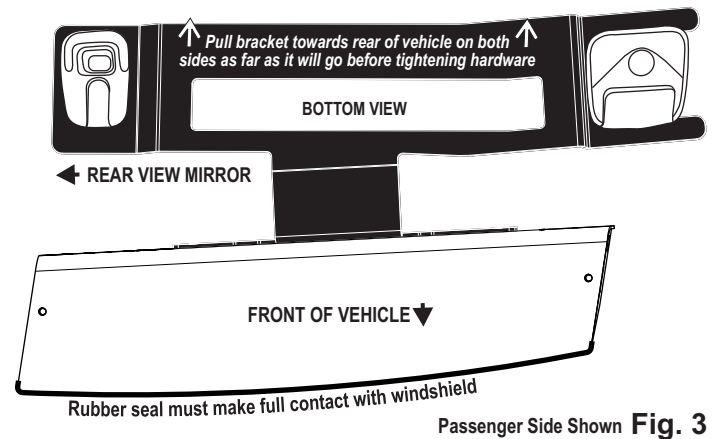
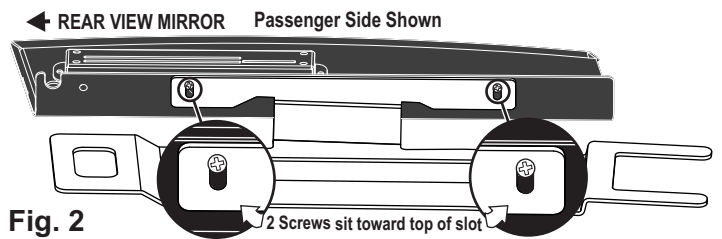

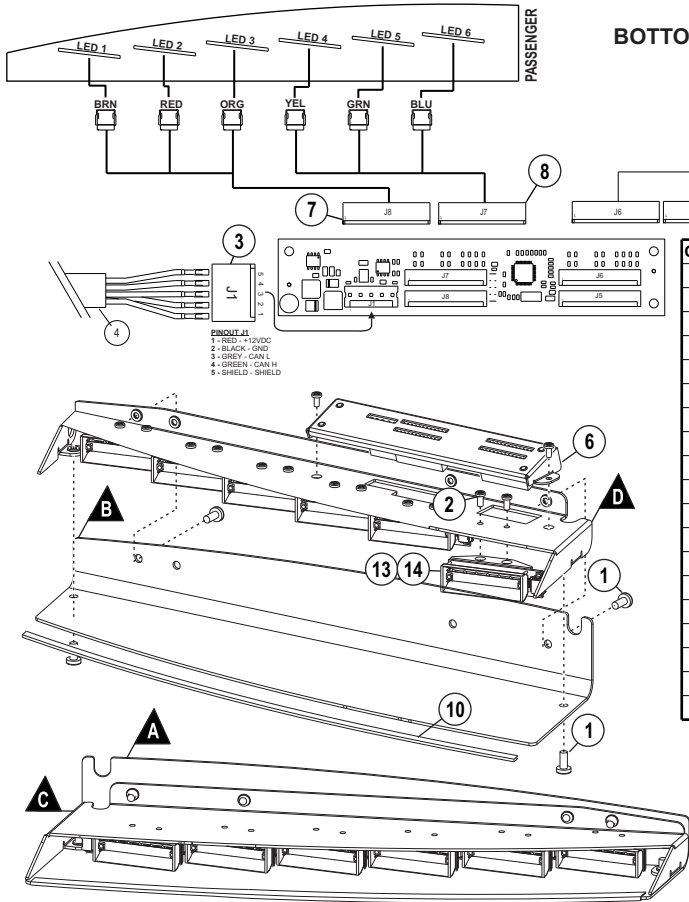

BOTTOM SIDE VIEW

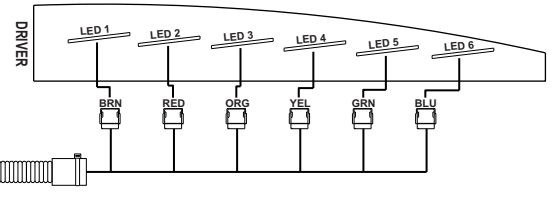

QTY	QTY	ITEM	PART NUMBER	DESCRIPTION
*	*		01-0687472-1	DUO INNER EDGE XLP, WC 6 LT
*	*		01-0687472-2	DUO INNER EDGE XLP, WC 12 LT
8	4	1	14-08228C-06D	SCREW, 8-32 X 3/8" PAN TORX HD ROLOK SS BLACK OXIDE
26	14	2	14-040216-04H	SCREW, 4-40 X 1/4 PPHMS 410SS BLACK PASSIVATE
1	1	3	39-1M18534-05	HOUSING, PLUG 5 POS 18 AWG SL-156 W/ LOCKING RAMP, LID
1	1	4	46-0746909-00	CABLE 4/C 16/20 GA TPR 20" SL-156
1	1	5	26-0215001-06	TY WRAP, 6" BLACK
1	1	6	01-026E763-00	SUB ASSY, WC I/O INNER-EDGE DUO XLP
1	1	7	46-076E764-00	HARNESS PASSENGER J8 INNER EDGE XLP
1	1	8	46-076E764-01	HARNESS PASSENGER J7 INNER EDGE XLP
1	-	9	46-076E764-02	HARNESS DRIVER J5&J6 INNER EDGE XLP
2	1	10	38-0546827-14	TRIM, SEAL HOUSING/WINDSHIELD 13.600" LENGTH INNER EDGE XLP
1	1	11	10-056E563-30	LABEL, WHELEN LOGO, 2.75" GREY
1	1	12	10-056E831-1	LABEL, INNER EDGE XLP, MM PIN DUO
6	-	13	01-026E756D-3	SUB ASSY, WARNING "WHT DUO INNER-EDGE XLP, DRVR
6	6	14	01-026E756P-3	SUB ASSY, WARNING "WHT DUO INNER-EDGE XLP, PASS
1	1	15	01-046E868-00	KIT, UNIVERSAL CONTROL POINT MODULE
1	1	16	79-000A005-00	DEFAULT, DUO INNER EDGE XLP WECAN
1	1	17	10-0546935-18	LABEL, UCP, DFLT, DUO INNER EDGE XLP

PART NUMBER KEY

NOTE: Mounting brackets and hardware not shown.

NOTE: There are Passenger and Driver specific lightheads.

01-0687472-

VERSION-
1 = 6 LT W/TD
2 = 12 LT W/O TD

YEAR/MAKE

- 1 = 2013 TAURUS/ INTERCEPTOR
- 2 = 2013 EXPLORER/SUV INTERCEPTOR
- 3 = 2013 F150
- 4 = 2013 F250-550
- 5 = 2013 EXPEDITION
- 6 = 2013 CHARGER
- 7 = 2013 RAM 1500
- 8 = 2013 DURANGO
- 9 = 2013 CAPRICE PPV
- A = 2014 IMPALA
- B = 2013 TAHOE/ SUBURBAN ALL PICKUPS
- C = 2013 FUSION
- D = 2014 TAHOE/ SUBURBAN ALL PICKUPS
- E = 2015 F150
- G = 2019 SILVERADO 1500
- H = 2020 EXPLORER/SUV INTERCEPTOR
- I = 2019 RAM 1500

SEE BELOW AND ON NEXT PAGE FOR VEHICLE SPECIFIC COMPONENT REQUIREMENTS



2013 - FORD F250-550

QTY	QTY	ITEM	PART NUMBER	DESCRIPTION
*	*		01-0687472-41	DUO INNER EDGE XLP, 6 LIGHT
*	*		01-0687472-42	DUO INNER EDGE XLP, 12 LIGHT
1	-	A	11-36E848-107	BASE, HOUSING DRVR 13 F250/350 INNER EDGE XLP BLACK
1	1	B	11-36E848-007	BASE, HOUSING PASS 13 F250/350 INNER EDGE XLP BLACK
1	-	C	11-26E849-107	COVER, TOP DRVR 2013 F250/350 DUO INNER EDGE XLP BLK
1	1	D	11-26E849-007	COVER, TOP PASS 2013 F250/350 DUO INNER EDGE XLP BLK
1	-	E	07-287511-123	BRACKET, VISOR MT DRVR F250/350 INNER EDGE XLP BLACK
1	1	F	07-287511-023	BRACKET, VISOR MT PASS F250/350 INNER EDGE XLP BLACK
4	2	G	14-08228C-06D	SCREW, 8-32 X 3/8" PAN TORX HD ROLOK SS BLACK OXIDE

2013 EXPEDITION

QTY	QTY	ITEM	PART NUMBER	DESCRIPTION
*	*		01-0687472-51	DUO INNER EDGE XLP, 6 LIGHT
*	*		01-0687472-52	DUO INNER EDGE XLP, 12 LIGHT
1	-	A	11-36G031-107	BASE, HOUSING DRVR EXPEDITION INNER EDGE XLP BLK
1	1	B	11-36G031-007	BASE, HOUSING PASS EXPEDITION INNER EDGE XLP BLK
1	-	C	11-26G042-107	COVER, TOP DRVR 14 EXPED. DUO INNER EDGE XLP BLK
1	1	D	11-26G042-007	COVER, TOP PASS 14 EXPED. DUO INNER EDGE XLP BLK
1	-	E	07-287845-123	BRACKET, VISOR MT DRVR EXPED. INNER EDGE XLP BLK
1	1	F	07-287846-023	BRCKT, VISOR MT PASS EXPED. INNER EDGE XLP BLK
4	2	G	14-08228C-06D	SCREW, 8-32 X 3/8" PAN TORX HD ROLOK SS BLK OXIDE

2013 - FUSION

QTY	QTY	ITEM	PART NUMBER	DESCRIPTION
*	*		01-0687472-C1	DUO INNER EDGE XLP, 6 LIGHT
*	*		01-0687472-C2	DUO INNER EDGE XLP, 12 LIGHT
1	-	A	11-36E891-107	BASE, HOUSING DRVR 2013 FUSION INNER EDGE XLP BLK
1	1	B	11-36E891-007	BASE, HOUSING PASS 2013 FUSION INNER EDGE XLP BLK
1	-	C	11-26E925-107	COVER, TOP DRVR FORD FUSION DUO INNER EDGE XLP BLK
1	1	D	11-26E925-007	COVER, TOP PASS FORD FUSION DUO INNER EDGE XLP BLK
1	-	E	07-287529-123	BRACKET, VISOR MT DRVR FUSION INNER EDGE XLP BLK
1	1	F	07-287529-023	BRACKET, VISOR MT PASS FUSION INNER EDGE XLP BLK
2	1	G	21-12081205-3	SCREW GROMMET FASTEX # 212-240602-040101
2	1	H	15-131416-202	SCREW, 1/4 X 1 1/4 PPHMS SS TYPE A
2	1	I	15-081416-160	SCREW, 8 X 1 PPHMS
4	2	J	14-08228C-06D	SCREW, 8-32 X 3/8" PAN TORX HD ROLOK SS BLK OXIDE

2013 - FORD TAURUS / INTERCEPTOR

QTY	QTY	ITEM	PART NUMBER	DESCRIPTION
*	*		01-0687472-11	DUO INNER EDGE XLP, 6 LIGHT
*	*		01-0687472-12	DUO INNER EDGE XLP, 12 LIGHT
1	-	A	11-36E737-107	BASE, HSNR DRVR 12 TAURUS DUO INNR EDGE XLP BLK
1	1	B	11-36E737-007	BASE, HSNR PASS 12 TAURUS DUO INNR EDGE XLP BLK
1	-	C	11-26E674-107	CVR, TOP DRVR 12 TAURUS DUO INNER EDGE XLP BLK
1	1	D	11-26E674-007	CVR, TOP PASS 12 TAURUS DUO INNER EDGE XLP BLK
1	-	E	07-287414-123	BRCKT, VISOR MT DRVR TAURUS INNER EDGE XLP BLK
1	1	F	07-287414-023	BRCKT, VISOR MT PASS TAURUS INNER EDGE XLP BLK
4	2	G	14-08228C-06D	SCREW, 8-32 X 3/8" PAN TORX HD ROLOK SS BLK OXIDE

2013 - FORD EXPLORER/SUV INTERCEPTOR

QTY	QTY	ITEM	PART NUMBER	DESCRIPTION
*	*		01-0687472-21	DUO INNER EDGE XLP, 6 LIGHT
*	*		01-0687472-22	DUO INNER EDGE XLP, 12 LIGHT
1	-	A	11-36E300-107	BASE, HSNR DRVR 13 FORD SUV INNER EDGE XLP
1	1	B	11-36E300-007	BASE, HSNR PASS 13 FORD SUV INNER EDGE XLP
1	-	C	11-26E741-107	CVR, TOP DRVR 13 FORD SUV DUO INNR EDGE XLP
1	1	D	11-26E741-007	CVR, TOP PASS 13 FORD SUV DUO INNR EDGE XLP
1	-	E	07-287371-123	BRCKT, VISOR MT DRVR 13 FORD SUV INNR EDGE XLP
1	1	F	07-287371-023	BRCKT, VISOR MT PASS 13 FORD SUV INNR EDGE XLP
4	2	G	14-08228C-06D	SCREW, 8-32 X 3/8" PAN TORX HD ROLOK SS BLK OXIDE

FORD 2013 - F150

QTY	QTY	ITEM	PART NUMBER	DESCRIPTION
*	*		01-0687472-31	DUO INNER EDGE XLP, 6 LIGHT
*	*		01-0687472-32	DUO INNER EDGE XLP, 12 LIGHT
1	-	A	11-36E829-107	BASE, HSNR DRVR 13 FORD F150 INNER EDGE XLP BLK
1	1	B	11-36E829-007	BASE, HSNR PASS 13 FORD F150 INNER EDGE XLP BLK
1	-	C	11-26E834-107	CVR, TOP DRVR 13 FORD F-150 DUO INNER EDGE XLP BLK
1	1	D	11-26E834-007	CVR, TOP PASS 13 FORD F-150 DUO INNER EDGE XLP BLK
1	-	E	07-287501-123	BRCKT, VISOR MT DRVR 13 F150 INNER EDGE XLP BLK
1	1	F	07-287501-023	BRCKT, VISOR MT PASS 13 F150 INNER EDGE XLP BLK
4	2	G	14-08228C-06D	SCREW, 8-32 X 3/8" PAN TORX HD ROLOK SS BLK OXIDE

CONTINUED ON NEXT PAGE

CONTINUED ON NEXT PAGE

2015 - F150

QTY	QTY	ITEM	PART NUMBER	DESCRIPTION
	*		01-0687472-E1	DUO INNER EDGE XLP, 6 LIGHT
*			01-0687472-E2	DUO INNER EDGE XLP, 12 LIGHT
1	-	A	11-36G373-107	BASE, HOUSING DRVR 15 FORD F150 INNER EDGE XLP BLK
1	1	B	11-36G373-007	BASE, HOUSING PASS 15 FORD F150 INNER EDGE XLP BLK
1	-	C	11-26G375-107	COVER, TOP DRVR 15 FORD F-150 DUO INNER EDGE XLP BLK
1	1	D	11-26G375-007	COVER, TOP PASS 15 FORD F-150 DUO INNER EDGE XLP BLK
1	-	E	07-287988-123	BRACKET, VISOR MT DRVR 15 F150 INNER EDGE XLP BLK
1	1	F	07-287988-023	BRACKET, VISOR MT PASS 15 F150 INNER EDGE XLP BLK
4	2	G	14-08228C-06D	SCREW, 8-32 X 3/8" PAN TORX HD ROLOK SS BLK OXIDE

2018 - EXPEDITION

QTY	QTY	ITEM	PART NUMBER	DESCRIPTION
	*		01-0687472-F1	DUO INNER EDGE XLP, 6 LIGHT
*			01-0687472-F2	DUO INNER EDGE XLP, 12 LIGHT
1	-	A	11-36J151-107	BASE, HOUSING DRVR EXPEDITION INNER EDGE XLP BLK
1	1	B	11-36J151-007	BASE, HOUSING PASS EXPEDITION INNER EDGE XLP BLK
1	-	C	11-26J157-107	COVER, TOP DRVR '18 EXPEDITION WC INNER EDGE XLP BLK
1	1	D	11-26J157-007	COVER, TOP PASS '18 EXPEDITION WC INNER EDGE XLP BLK
1	-	E	07-288533-123	BRACKET, VISOR MT DS EXPEDITION INNER EDGE XLP BLK
1	1	F	07-288533-023	BRACKET, VISOR MT PS EXPEDITION INNER EDGE XLP BLK
4	2	G	14-08228C-06D	SCREW, 8-32 X 3/8" PAN TORX HD ROLOK SS BLK OXIDE

2020 - EXPLORER/SUV INTERCEPTOR

QTY	QTY	ITEM	PART NUMBER	DESCRIPTION
	*		01-0687472-H1	FINAL, DUO INNER EDGE XLP, 6 LIGHT
*			01-0687472-H2	FINAL, DUO INNER EDGE XLP, 12 LIGHT
1	-	A	11-36J428-107	BASE, HOUSING DRVR 2020 UTILITY INNER EDGE XLP BLACK
1	1	B	11-36J428-007	BASE, HOUSING PASS 2020 UTILITY INNER EDGE XLP BLACK
1	-	C	11-26J430-107	COVER, TOP DRVR 2020 UTILITY WC INNER EDGE XLP BLACK
1	1	D	11-26J430-007	COVER, TOP PASS 2020 UTILITY WC INNER EDGE XLP BLACK
1	-	E	07-288609-123	BRACKET, VISOR MT DRVR 2020 UTILITY INNER EDGE XLP BLK
1	1	F	07-288609-023	BRACKET, VISOR MT PASS 2020 UTILITY INNER EDGE XLP BLK
4	2	G	14-08228C-06D	SCREW, 8-32 X 3/8" PAN TORX HD ROLOK SS BLACK OXIDE

2013 - DODGE RAM 1500

QTY	QTY	ITEM	PART NUMBER	DESCRIPTION
	*		01-0687472-71	DUO INNER EDGE XLP, 6 LIGHT
*			01-0687472-72	DUO INNER EDGE XLP, 12 LIGHT
1	-	A	11-36E862-107	BASE, HOUSING DRVR RAM 1500 INNER EDGE XLP BLK
1	1	B	11-36E862-007	BASE, HOUSING PASS RAM 1500 INNER EDGE XLP BLK
1	-	C	11-26E882-107	COVER, TOP DRVR DODGE RAM 1500 DUO IN. EDGE XLP BLK
1	1	D	11-26E882-007	COVER, TOP PASS DODGE RAM 1500 DUO IN. EDGE XLP BLK
1	-	E	07-287518-123	BRACKET, VISOR MT DRVR RAM 1500 INNER EDGE XLP BLK
1	1	F	07-287518-023	BRACKET, VISOR MT PASS RAM 1500 INNER EDGE XLP BLK
4	2	G	14-08228C-06D	SCREW, 8-32 X 3/8" PAN TORX HD ROLOK SS BLK OXIDE
2	1	H	15-081416-160	SCREW, 8-32 X 3/8" PAN TORX HD ROLOK SS BLK OXIDE

2013 - DODGE CHARGER

QTY	QTY	ITEM	PART NUMBER	DESCRIPTION
	*		01-0687472-61	DUO INNER EDGE XLP, 6 LIGHT
*			01-0687472-62	DUO INNER EDGE XLP, 12 LIGHT
1	-	A	11-36E264-107	BASE, HOUSING DRVR 12 CHARGER INNER EDGE XLP BLK
1	1	B	11-36E264-007	BASE, HOUSING PASS 12 CHARGER INNER EDGE XLP BLK
1	-	C	11-26E670-107	COVER, TOP DRVR 12 CHARGER DUO INNER EDGE XLP BCK
1	1	D	11-26E670-007	COVER, TOP PASS 12 CHARGER DUO INNER EDGE XLP BLK
1	-	E	07-287356-123	BRACKET, VISOR MT DRVR CHARGER INNER EDGE XLP BLK
1	1	F	07-287356-023	BRACKET, VISOR MT PASS CHARGER INNER EDGE XLP BLK
4	2	G	14-08228C-06D	SCREW, 8-32 X 3/8" PAN TORX HD ROLOK SS BLACK OXIDE

2013 - DODGE DURANGO

QTY	QTY	ITEM	PART NUMBER	DESCRIPTION
	*		01-0687472-81	DUO INNER EDGE XLP, 6 LIGHT
*			01-0687472-82	DUO INNER EDGE XLP, 12 LIGHT
1	-	A	11-36F186-107	BASE, HOUSING DRVR 13 DURANGO INNER EDGE XLP BLK
1	1	B	11-36F186-007	BASE, HOUSING PASS 13 DURANGO INNER EDGE XLP BLK
1	-	C	11-26F188-107	COVER, TOP DRVR DURANGO DUO INNER EDGE XLP BLK
1	1	D	11-26F188-007	COVER, TOP PASS DURANGO DUO INNER EDGE XLP BLK
1	-	E	07-287616-123	BRACKET, VISOR MT DRVR DURANGO INNER EDGE XLP BLK
1	1	F	07-287616-023	BRACKET, VISOR MT PASS DURANGO INNER EDGE XLP BLK
4	2	G	14-08228C-06D	SCREW, 8-32 X 3/8" PAN TORX HD ROLOK SS BLACK OXIDE

2019 - RAM 1500

QTY	QTY	ITEM	PART NUMBER	DESCRIPTION
	*		01-0687472-11	FINAL, DUO INNER EDGE XLP, 6 LIGHT
*			01-0687472-12	FINAL, DUO INNER EDGE XLP, 12 LIGHT
1	-	A	11-36J525-107	BASE, HOUSING DRVR 19 RAM 1500 INNER EDGE XLP
1	1	B	11-36J525-007	BASE, HOUSING PASS 19 RAM 1500 INNER EDGE XLP
1	-	C	11-26J524-107	COVER, TOP DRVR 2019 RAM 1500 WC INNER EDGE XLP
1	1	D	11-26J524-007	COVER, TOP PASS 2019 RAM 1500 WC INNER EDGE XLP
1	-	E	07-288641-123	BRACKET, VISOR MT DRVR 2019 RAM 1500 INNER EDGE XLP
1	1	F	07-288641-023	BRACKET, VISOR MT PASS 2019 RAM 1500 INNER EDGE XLP
4	2	G	14-08228C-06D	SCREW, 8-32 X 3/8" PAN TORX HD ROLOK SS BLACK OXIDE
2	1	I	15-081416-160	SCREW, 8 X 1 PPHSMS

2013 - CAPRICE PPV

QTY	QTY	ITEM	PART NUMBER	DESCRIPTION
	*		01-0687472-91	DUO INNER EDGE XLP, 6 LIGHT
*			01-0687472-92	DUO INNER EDGE XLP, 12 LIGHT
1	-	A	11-36E494-107	BASE, HOUSING DRVR 12 CAPRICE INNER EDGE XLP BLK
1	1	B	11-36E494-007	BASE, HOUSING PASS 12 CAPRICE INNER EDGE XLP BLK
1	-	C	11-26E740-107	COVER, TOP DRVR 12 CAPRICE DUO INNER EDGE XLP BLK
1	1	D	11-26E740-007	COVER, TOP PASS 12 CAPRICE DUO INNER EDGE XLP BLK
1	-	E	07-287419-123	BRACKET, VISOR MT DRVR CAPRICE INNER EDGE XLP BLK
1	1	F	07-287419-023	BRACKET, VISOR MT PASS CAPRICE INNER EDGE XLP BLK
4	2	G	14-08228C-06D	SCREW, 8-32 X 3/8" PAN TORX HD ROLOK SS BLK OXIDE
2	1	H	15-10141B-162	SCREW, 10 X 1 PPH SMS TYPE A SS BLK OXIDE

2014 - IMPALA

QTY	QTY	ITEM	PART NUMBER	DESCRIPTION
	*		01-0687472-A1	DUO INNER EDGE XLP, 6 LIGHT
*			01-0687472-A2	DUO INNER EDGE XLP, 12 LIGHT
1	-	A	11-36G260-107	BASE, HOUSING DRVR 2014 IMPALA INNER EDGE XLP BLK
1	1	B	11-36G260-007	BASE, HOUSING PASS 2014 IMPALA INNER EDGE XLP BLK
1	-	C	11-26G262-107	COVER, TOP DRVR 2014 IMPALA DUO INNER EDGE XLP BLK
1	1	D	11-26G262-007	COVER, TOP PASS 2014 IMPALA DUO INNER EDGE XLP BLK
1	-	E	07-287946-123	BRACKET, VISOR MT DRVR IMPALA INNER EDGE XLP BLK
1	1	F	07-287946-023	BRACKET, VISOR MT PASS IMPALA INNER EDGE XLP BLK
4	2	G	14-08228C-06D	SCREW, 8-32 X 3/8" PAN TORX HD ROLOK SS BLK OXIDE

2013 - TAHOE/SUBURBAN/ALL PICKUPS

QTY	QTY	ITEM	PART NUMBER	DESCRIPTION
	*		01-0687472-B1	DUO INNER EDGE XLP, 6 LIGHT
*			01-0687472-B2	DUO INNER EDGE XLP, 12 LIGHT
1	-	A	11-36E644-107	BASE, HSNR DRVR 12 TAHOE INR EDGE XLP BLK
1	1	B	11-36E644-007	BASE, HSNR PASS 12 TAHOE INR EDGE XLP BLK
1	-	C	11-26E761-107	COVER, DRVR 2012 TAHOE DUO INR EDGE XLP BLK
1	1	D	11-26E761-007	COVER, PASS 2012 TAHOE DUO INR EDGE XLP BLK
1	-	E	07-287449-123	BRCKT, VISOR MT DRVR TAHOE INR EDGE XLP BLK
1	1	F	07-287449-023	BRCKT, VISOR MT PASS TAHOE INR EDGE XLP BLK
4	2	G	14-08228C-06D	SCREW, 8-32 X 3/8" PAN TORX HD ROLOK SS BLK OX.

2014 - TAHOE/SUBURBAN/ALL PICKUPS

QTY	QTY	ITEM	PART NUMBER	DESCRIPTION
	*		01-0687472-D1	DUO INNER EDGE XLP, 6 LIGHT
*			01-0687472-D2	DUO INNER EDGE XLP, 12 LIGHT
1	-	A	11-36F641-107	BASE, HSNR DRVR 14 TAHOE INNER EDGE XLP BLK
1	1	B	11-36F641-007	BASE, HSNR PASS 14 TAHOE INNER EDGE XLP BLK
1	-	C	11-26F653-107	COVER, TOP DRVR 2014 TAHOE DUO INR EDGE XLP BLK
1	1	D	11-26F653-007	COVER, TOP PASS 2014 TAHOE DUO INR EDGE XLP BLK
1	-	E	07-287726-123	BRCKT, VISOR MT DRVR TAHOE INNER EDGE XLP BLK
1	1	F	07-287726-023	BRCKT, VISOR MT PASS TAHOE INNER EDGE XLP BLK
4	2	G	14-08228C-06D	SCREW, 8-32 X 3/8" PAN TORX HD ROLOK SS BLK OXIDE

2019 - SILVERADO 1500

QTY	QTY	ITEM	PART NUMBER	DESCRIPTION
	*		01-0687472-G1	DUO INNER EDGE XLP, 6 LIGHT
*			01-0687472-G2	DUO INNER EDGE XLP, 12 LIGHT
1	-	A	11-36J270-107	BASE, HOUSING DRVR SILVERADO 2019 INNER EDGE XLP BLK
1	1	B	11-36J270-007	BASE, HOUSING PASS SILVERADO 2019 INNER EDGE XLP BLK
1	-	C	11-26J272-107	COVER, TOP DRVR 19 SILVERADO WC INNER EDGE XLP BLK
1	1	D	11-26J272-007	COVER, TOP PASS 19 SILVERADO WC INNER EDGE XLP BLK
1	-	E	07-288558-123	BRACKET, VISOR MT DRVR SILVERADO 2019 INNER EDGE XLP BLK
1	1	F	07-288558-023	BRACKET, VISOR MT PASS SILVERADO 2019 INNER EDGE XLP BLK
4	2	G	14-08228C-06D	SCREW, 8-32 X 3/8" PAN TORX HD ROLOK SS BLK OXIDE