





















DIRECTIONAL LEDS



ED3000 SERIES Stop-Tail-Turn-Reverse and Warning Light Combo

These low-profile, multifunctional lights maximize visibility on the back of the vehicle. Use them to indicate stop-turn-tail-reverse with steady burn red and white colors. When warning lights are activated, the dual-color lights provide 69 attention-grabbing flash patterns. Installation is a breeze with a female PL3 or AMP connector and grommet mount or a flange mount option (see accessories below).

Models

PART NO.	SHAPE	CONNECTOR	ILLUMINATION COLOR OPTIONS
ED3040XX		PL3	 AB  AG  AW
ED3040XX-AMP3S		AMP	 AB  AG  AW
ED3060XX		PL3	 AB  AG  AW
ED3060XX-AMP3S		AMP	 AB  AG  AW
ED3080AW		PL3	 AW

Replace "X" in part number with desired color: A=amber, B=blue, G=green, W=white

Design Features

- 12-24 VDC
- Clear center: reverse/warning, red perimeter: stop-turn-tail
- High output LEDs offer low maintenance, long life and low current consumption
- Ultrasonically sealed housing
- Grommet mount included to fit in standard 4" rounded or 6" oval tail light applications
- Flange mount and bezel available with optional accessories
- Vibration and shock resistant construction
- Connector for ground, stop/turn, tail
- Temperature Range: -22°F to +122°F (-30°C to +50°C)

ED3040

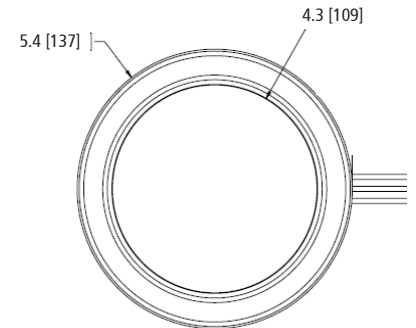

ED3060 & ED3080

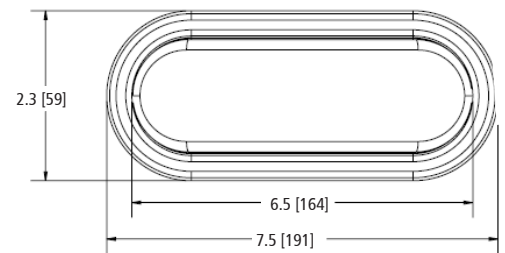

Accessories

EZ3040FLG	Flange for ED3040AW
EZ3060FLG	Flange for ED3060AW
EZ3080BZB	Black Bezel for ED3080AW
EZ3080BZC	Chrome Bezel for ED3080AW

