

Legend® LGD and LPX Light Bars



Installation, Operation, and Service Manual

Limited Warranty

This product is subject to and covered by a limited warranty, a copy of which can be found at www.fedsig.com/SSG-Warranty. A copy of this limited warranty can also be obtained by written request to Federal Signal Corporation, 2645 Federal Signal Drive, University Park, IL 60484, email to info@fedsig.com or call +1 708-534-3400.

This limited warranty is in lieu of all other warranties, express or implied, contractual or statutory, including, but not limited to the warranty of merchantability, warranty of fitness for a particular purpose and any warranty against failure of its essential purpose.



2645 Federal Signal Drive
University Park, Illinois 60484

www.fedsig.com

Customer Support

Police/Fire-EMS: 800-264-3578 • +1 708 534-3400

Work Truck: 800-824-0254 • +1 708 534-3400

Technical Support 800-433-9132 • +1 708 534-3400

All trademarks are property of their respective owners.

Contents

Safety Messages.....	6
Safety Message to Installers and Service Personnel of Warning Light Equipment	6
Safety Message to Operators of Warning Light Equipment.....	9
Overview of the Legend Light Bar	10
Product Features	10
Applications	11
Product Specifications.....	11
Approvals.....	13
Model LGD and LPX Flash Pattern Compliances.....	13
Model LPXD Light Activation.....	15
Model LPXD Flash Pattern Compliances.....	16
Changing the Default MODE 1 Flash Pattern	16
Changing the Default MODE 2 Flash Pattern	17
Preparing the Legend for Installation.....	18
Unpacking the Light Bar	18
Changing the Default Settings.....	18
Wiring the Legend in the Vehicle	26
Wiring the Light Bar in the Vehicle.....	26
Mounting the Serial Interface Module.....	27
Wiring the Serial Interface Module	29
Wiring the Stop/Turn/Tail Lights.....	36
Wiring the Takedown or Worklights (LGD24 or LGD32 Models Only).....	37
Wiring for 12-inch Legend.....	37
Maintaining and Servicing the Legend.....	38
Servicing the Light Bar Domes	38
Replacing a Light Bar Base	40
Replacing an End Gasket	42
Replacing a Lip Seal.....	42
Adjusting the Aim of the HotFoot LED Assemblies	43
Replacing the ROC Panel Assemblies	44
Servicing the Light Bar Controller.....	44
Cleaning the Domes	47
Cleaning the Reflectors.....	47
Troubleshooting the Light Bar.....	48
Getting Technical Support and Service.....	50
Getting Repair Service	50
Ordering Replacement Parts	51
Appendix A: Wiring Schematics	52
An Overview of the Discrete-Wired 24-inch Legend Light Bar	52

Figures

Figure 1	Electrical connections for testing and reprogramming.....	19
Figure 2	Serial Interface Module.....	21
Figure 3	Light options for Legend light bars.....	25
Figure 4	Relay-isolating devices with large filter capacitors	28
Figure 5	Wiring block diagram	29
Figure 6	SignalMaster 331105 controller (External)	32
Figure 7	SmartSiren SS2000SM Series controller (External)	33
Figure 8	SignalMaster control functions wired to 12 Vdc for Internal control (factory default)	34
Figure 9	SignalMaster control functions wired to ground for External control	35
Figure 10	Stop/turn/tail wiring between light bar and vehicle harness	36
Figure 11	Worklight wiring between light bar and switched +12 Vdc.....	37
Figure 12	Internal/External flasher wiring for 12-inch Legends	37
Figure 13	Four barrel nuts in passenger-side end dome.....	39
Figure 14	Base removed from aluminum extrusion.....	41
Figure 15	End gasket in the end base cavity	42
Figure 16	Lip seal on edge of plastic dome	43
Figure 17	Adjusting the aim of the LED assembly	43
Figure 18	Controller and standoffs removed from ROC panel.....	45
Figure 19	Fuses on light bar controller PCB	46

Tables

Table 1	LED Lights.....	11
Table 2	Light Bar Dimensions.....	12
Table 3	Technical Specifications	12
Table 4	Model 8583446 SP.....	13
Table 5	Flash pattern compliances to SAE J845 and CCR Title 13.....	14
Table 6	Flash pattern compliances to NFPA.....	15
Table 7	Model LPXD control wires for light activation.....	16
Table 8	Model LPXD available flash patterns.....	16
Table 9	Control wires from the Serial Interface Module.....	20
Table 10	SW-2 DIP Switch Settings.....	21
Table 11	Switch settings for INTERSECTION operation.....	24

Table 12	Cross reference for controller leads.....	32
Table 13	Domes and ROC panel assemblies for LGD/LPX models.....	39
Table 14	Troubleshooting tips	48
Table 15	Legend replacement parts.....	51

Schematics

Schematic A 1	Discrete-wired 24-inch Legend light bar.....	52
Schematic A 2	Typical connections with a SignalMaster controller (External)	53
Schematic A 3	Typical connections with a SW400SS Switch Module (Internal).....	54
Schematic A 4	Typical connections with a SmartSiren controller.....	55
Schematic A 5	Typical connections with a non-SignalMaster controller	56
Schematic A 6	Typical connections with a PA640 controller.....	57
Schematic A 7	Typical connections for LPXD Discrete Legend and LPX Legend.....	58
Schematic A 8	Typical connections for LPXD Discrete Legend and LPX Legend with Preterminated Weather tight Connectors	59

Safety Messages

For your safety, read this manual thoroughly before installing, operating, and servicing the Legend® light bar. The safety messages presented in this section and throughout the manual are reminders to exercise extreme care at all times. To download copies of the manual, go to www.fedsig.com or call the Federal Signal Service Department at 1-800-433-9132, 7 AM to 5 PM, Monday through Friday (CT).

Safety Message to Installers and Service Personnel of Warning Light Equipment

⚠ WARNING

People's lives depend on your proper installation and servicing of Federal Signal products. It is important to read and follow all instructions shipped with this product. Listed below are some other important safety instructions and precautions you should follow.

Before Installation or Service

Qualifications

- To properly install or service this equipment, you must have a good understanding of automotive mechanical and electrical procedures and systems, along with proficiency in the installation and service of safety warning equipment. Always refer to the vehicle service manuals when performing equipment installations on a vehicle.

Light Hazards

- To be an effective warning device, this product produces bright light that can be hazardous to your eyesight when viewed at a close range. Do not stare directly into this lighting product at a close range, or permanent damage to your eyesight may occur.
- Do not install the light system in an area that would block, impair, or blind the driver's vision. Ensure that the light system is mounted in a position that is outside of the driver's field of vision, so the driver can safely operate the vehicle.
- Federal Signal power supplies and light heads are designed to work together as a system. Combining light heads and a power supply from different manufacturers may reduce the warning effectiveness of the lighting system and may damage the components. Verify or test your combination to ensure that the system works together and meets federal, state, and local standards or guidelines.

Electrical Hazards

- A light system is a high current system. In order for the system to function properly, a separate negative (–) connection and positive (+) connection must be made. All negative connections should be connected to the negative battery terminal, and a suitable fuse should be installed on the positive battery terminal connection as close to the battery as possible. Ensure that all wires and fuses are rated correctly to handle the device and system amperage requirements.

- Never attempt to install aftermarket equipment that connects to the vehicle wiring without reviewing a vehicle wiring diagram available from the vehicle manufacturer. Ensure that your installation will not affect vehicle operation or mandated safety functions or circuits. Always check the vehicle for proper operation after installation.
- The lighting system components, especially light bulbs, strobe tubes, LEDs, and the outer housing, get hot during operation. Be sure to disconnect power to the system and allow the system to cool down before handling any components of the system.
- Do not mount a radio antenna within 18 inches (45.7 cm) of the lighting system. Placing the antenna too close to the lighting system could cause the lighting system to malfunction or be damaged by strong radio fields. Mounting the antenna too close to the lighting system may also cause the radio noise emitted from the lighting system to interfere with the reception of the radio transmitter and reduce radio reception.
- Do not attempt to wash any unsealed electrical device while it is connected to its power source.

During Installation and Service

- DO NOT get metal shavings inside the product. Metal shavings in the product can cause the system to fail. If drilling must be done near the unit, place an ESD-approved cover over the unit. Inspect the unit after mounting to be sure there are no shavings present in or near the unit.
- To avoid a battery explosion, always disconnect the negative battery cable first and reconnect it last. Avoid causing a spark when connecting near or to the battery. The gases produced by a battery can cause a battery explosion that could result in vehicle damage and serious injury.
- DO NOT connect this system to the vehicle battery until ALL other electrical connections are made, mounting of all components is complete, and you have verified that no shorts exist. If the wiring is shorted to the vehicle body or frame, high current conductors can cause hazardous sparks, resulting in electrical fires or flying molten metal.
- DO NOT install equipment or route wiring (or the plug in cord) in the deployment path of an airbag.
- If a vehicle seat is temporarily removed, verify with the vehicle manufacturer if the seat needs to be recalibrated for proper airbag deployment.
- Before mounting any components, check the manual to ensure that the component you are installing is suitable for use in that area of the vehicle. Many components are not suitable for use in the engine compartment or other extreme environmental exposure areas.
- When drilling into a vehicle structure, ensure that both sides of the surface are clear of anything that could be damaged. Remove all burrs from drilled holes. To prevent electrical shorts, grommet all drilled holes through which wiring passes. Ensure that the mounting screws do not cause electrical or mechanical damage to the vehicle.
- Refer to the manual packed with the lighting system for proper electrical connections, additional precautions, and information.

- Because vehicle roof construction and driving conditions vary, do not drive a vehicle with a magnetically mounted warning light installed. The light could fly off the vehicle causing injury or damage. Repair of damage incurred because of ignoring this warning shall be the sole responsibility of the user.
- To avoid denting the roof of the vehicle, place the light bar mounting feet as close to the outer edge of the roof as possible.
- Roof damage can occur if the hook adjustment bolts are overtightened. Torque each hook adjustment bolt 6 ft-lb to 7 ft-lb. Install keeper plates,
- Locate the light system controls so the VEHICLE and CONTROLS can be operated safely under all driving conditions.

After Installation or Service

- After installation, test the light system to ensure that it is operating properly.
- Test all vehicle functions, including horn operation, vehicle safety functions, and vehicle light systems, to ensure proper operation. Ensure that the installation has not affected the vehicle operation or changed any vehicle safety function or circuit.
- Scratched or dull reflectors, mirrors, or lenses will reduce the effectiveness of the lighting system. Avoid heavy pressure and the use of caustic or petroleum-based products when cleaning the lighting system. Replace any optical components that may have been scratched or crazed during system installation.
- Do not attempt to activate or deactivate the light system control while driving in a hazardous situation.
- Frequently inspect the light system to ensure that it is operating properly and is securely attached to the vehicle.
- After installation and testing are complete, provide a copy of these instructions to instructional staff and all operating personnel.
- File these instructions in a safe place and refer to them when maintaining and/or reinstalling the product.
- Holding power of magnetic mounting systems is dependent upon surface finish, surface flatness, and thickness of the steel mounting surface. Therefore, to promote proper magnetic mounting:
 - Mounting surface and magnets must be kept clean, dry, and free of foreign particles that prevent good surface contact.
 - Ensure that mounting surface is flat.
 - A magnet mounting system should not be used on vehicles with vinyl tops.
 - Avoid quick acceleration and hard stops to prevent sliding of light assembly on mounting surface.

Failure to follow all safety precautions and instructions may result in property damage, serious injury, or death.

RETAIN AND REFER TO THIS MESSAGE

Safety Message to Operators of Warning Light Equipment

WARNING

People's lives depend on your safe use of our products. Listed below are some important safety instructions and precautions you should follow.

- Do not attempt to activate or deactivate the light system control while driving in a hazardous situation.
- Although your warning system is operating properly, it may not be completely effective. People may not see or heed your warning signal. You must recognize this fact and continue to drive cautiously.
- Situations may occur that obstruct your warning signal when natural and man-made objects are between your vehicle and others, such as raising your hood or trunk lid. If these situations occur, be especially careful.
- All effective sirens and horns produce loud sounds that may cause, in certain situations, permanent hearing loss. You and your passengers should consider taking appropriate safety precautions, such as wearing hearing protection.
- In order to be an effective warning device, this product produces bright light that can be hazardous to your eyesight when viewed at a close range. Do not stare directly into this lighting product at a close range, or permanent damage to your eyesight may occur.
- The effectiveness of an interior mounted warning light depends on the clarity, the tinting, and the angle of the glass it is being placed behind. Tinting, dirt, defects, and steeply angled glass reduce the light output of the warning light. This may reduce the effectiveness of the light as a warning signal. If your vehicle has dirty, tinted, or steeply angled glass, use extra caution when driving your vehicle or blocking the right of way with your vehicle.
- It is important that you fully understand how to safely operate this warning system before use.
- Operate your vehicle and its light/sound system in accordance with your department's Standard Operating Procedures.
- If a selected function does not perform properly or if any of the lamps remain illuminated when the control is off, disconnect the power connector from the control unit and contact the nearest service center.
- At the start of your shift, ensure that the entire warning light system and the siren system are securely attached and operating properly.

Failure to follow these precautions may result in property damage, serious injury, or death.

RETAIN AND REFER TO THIS MESSAGE

Overview of the Legend Light Bar

The Legend and Legend LPX light bars are single-level LED light bars with ROC™ (Reliable On-Board Circuitry) and Solaris® LED technologies. ROC eliminates approximately 85 percent of potential failure points by incorporating a printed circuit board (PCB) in one assembly to substantially reduce the number of electrical connections. Solaris S2 LED modules use offset, complex reflector surfaces for accurate beam shaping and the highest optical efficiency. The reflectors' overlapping, 360-degree lighting eliminates weak spots and provides off-axis warning around the light bar.

The light bar's internal microprocessor supplies three priority operational modes and a library of 26 flash patterns. To increase the safety of officers, pedestrians, and motorists, the light bar has standard front and rear cutoff, dimming, and intersection warning. Bright white LED takedown lights, LED alley lights, and LED worklights are available in the light bar.

Flash patterns are controlled through the light bar's CAT5 serial communication cable. The cable connects to the Federal Signal Serial Interface Module (Model Number 8583446), the Federal Signal Six-Button Serial Controller (Model Number 8623133), the Federal Signal Three-Button Serial Controller (Model Number 8623141), or the Six-Button Wireless Controller (8623137). With the Serial Interface Module, the Legend can be activated by Federal Signal light bar controllers, SignalMaster directional light controllers, or by individual low-current switch boxes. (SignalMaster directional warning lights are not available with the Model LGD12, LGD24, LGD32, LPX24, LPX32, or any of LPXD models.) The programmable Six-Button Serial Controller and the Six-Button Wireless Controller have six illuminated buttons and a three-position slide switch with LED indicators for operating the light bar. The programmable Three-Button Serial Controller has three illuminated buttons and LED indicators for operating the light bar.

The Legend is available in seven lengths: 12 inches (Model LGD12) (sold as a set), 24 inches (Model LGD24) 32 inches (Model LGD32), 45 inches (Model LGD45), 53 inches (Model LGD53), 61 inches (Model LGD61), and 70 inches (Model LGD70). Also available is the Discrete-Wired 24-inch Model Legend, which has one flash pattern and does not connect to the Serial Interface Module. The Legend LPX is available in six lengths: 24 inches (Model LPX24), 32 inches (LPX32), 45 inches (Model LPX45), 53 inches (Model LPX53), 61 inches (Model LPX61), and 70 inches (Model LPX70).

Product Features

Additional features include:

- Design provides superior 360-degree intersection warning.
- Bright white LED takedowns are long life and significantly reduce power consumption.
- Light bar housing is wind tunnel tested to ensure durability at high speeds and maximum fuel efficiency.

- Available LED colors include amber, blue, red, green, and white.
- Built-in SignalMaster directional warning capability is standard on all Legend 45-inch, 53-inch, 61-inch, and 70-inch, and Legend LPX serially controlled models of the same lengths. SignalMaster flash patterns can be activated with switched 12 Vdc, a SignalMaster controller, or six-button controller.
- The SignalMaster option is not available in any LPXD model.
- Five-year warranty on LEDs.
- Easily repaired and reconfigured without taking the light bar off the vehicle.

Applications

- Police, Fire, and EMS Vehicles
- Heavy-Duty Towing and Recovery Vehicles
- Parking enforcement and community service vehicles
- Private security vehicles

Product Specifications

Operating and technical specifications for the Legend Model LGD and Legend Model LPX are listed in this section by lighting option and model.

Table 1 LED Lights

Lighting Option	Current Draw	Lamp Technology	Reflector Style
LED takedown lights/worklights (Legend LGD)	1.0 A**	Six bright white LEDs	Offset, compound-curve, polished spot beam reflector
LED takedown lights/worklights (Legend LPX)	1.0 A**	Four bright white LEDs	Offset, compound-curve, polished spot beam reflector
LED alley light	0.5 A*	Three bright white lights	Offset, compound-curve, polished reflector
Solaris LED, Mainbar (Legend LGD)	1.0 A**	Six high-brightness LEDs	Offset, compound-curve, polished reflector
Solaris LED, Mainbar (Legend LPX)	1.0 A**	Four high-brightness LEDs	Offset, compound-curve, polished reflector

*Amperage per pair with flashing takedown and alley lights

**Amperage in STEADY BURN mode

Table 2 Light Bar Dimensions

Model	Length	Height	Width	Weight*
LGD24/ LPX24	24.25 in (61.6 cm)	2.5 in (6.4 cm)	11.2 in (28.4 cm)	16.6 lb (7.5 kg)
LGD32/ LPX32	32.5 in (82.6 cm)	2.5 in (6.4 cm)	11.2 in (28.4 cm)	18.5 lb (8.4 kg)
LGD45/ LPX45	44.5 in (113.0 cm)	2.5 in (6.4 cm)	11.2 in (28.4 cm)	20.4 lb (9.3 kg)
LGD53/ LPX53	52.7 in (133.9 cm)	2.5 in (6.4 cm)	11.2 in (28.4 cm)	24.2 lb (11.0 kg)
LGD61/ LPX61	60.9 (154.7 cm)	2.5 in (6.4 cm)	11.2 in (28.4 cm)	28.0 lb (12.7 kg)
LGD70/ LPX70	69.1 (175.5 cm)	2.5 in (6.4 cm)	11.2 in (28.4 cm)	31.81 lb (14.4 kg)

*With standard mounting feet

Table 3 Technical Specifications

Model	Electrical Potential	Current Draw with LED Takedowns*	Operating Temperature
LGD24	12.8 Vdc	11.0 A	-22°F to +149°F (-30°C to +65°C)
LPX24		9.0	
LGD32	12.8 Vdc	15.0 A	-22°F to +149°F (-30°C to +65°C)
LPX32		13.0 A	
LGD45	12.8 Vdc	19.0 A	-22°F to +149°F (-30°C to +65°C)
LPX45		17.0 A	
LGD53	12.8 Vdc	23.0 A	-22°F to +149°F (-30°C to +65°C)
LPX53		21.0 A	
LGD61	12.8 Vdc	27.0 A	-22°F to +149°F (-30°C to +65°C)
LPX61		25.0 A	
LGD70	12.8 Vdc	31.0 A	-22°F to +149°F (-30°C to +65°C)
LPX70Z		29.0 A	
LPX70D		27.0 A	

*Max. amperage for a typically loaded light bar with all lights flashing

Serial Interface Module

Table 4 Model 8583446 SP

Length	Height	Width	Shipped with a 24-pin cable harness (1751364) that is 3 feet long. The harness connects to the module's J1 outlet.
6.25 in (15.9 cm)	3.16 in (8.0 cm)	1.06 in (2.7 cm)	

Approvals

- SAE J845 Light Output (select flash patterns, Table 5 on page 14)
- CCR Title 13 (select flash patterns and LGD models, Table 5 on page 14)
- SAE 1113/41 RFI
- FCC Part 15
- NFPA (Table 6 on page 15)

Model LGD and LPX Flash Pattern Compliances

The patterns listed as “Yes” (Y) in Tables 5 and 6 comply with the flash requirements and light output requirements of the lighting standard in the table header. Patterns listed as “No” (N) do not comply with either the flash requirements or the light output of the standard. You should use a non-compliant pattern only after the people you are trying to warn have been trained to recognize the pattern as a warning signal. End users are responsible for choosing the light patterns that meet their jurisdiction’s requirements.

Overview of the Legend Light Bar

Table 5 Flash pattern compliances to SAE J845 and CCR Title 13

Pattern	SAE J845			CCR Title 13			CCR Title 13 (Amber) ****		
	LGD24/* LPX24	LGD45/ LPX45	LGD53/ LPX53	LGD24@	LGD45@	LGD53@	LGD24S	LGD45S	LGD53S
P1	Y	Y	Y	Y	Y	Y	Y	Y	Y
P2	Y	Y	Y	Y	Y	Y	Y	Y	Y
P3	Y	Y	Y	Y	Y	Y	Y	Y	Y
P4	Y	Y	Y	N	Y	Y	Y	Y	Y
P5	Y	Y	Y	Y	Y	Y	Y	Y	Y
P6	Y	Y	Y	N	Y	N	Y	Y	Y
P7	Y	Y	N	Y	N	N	Y	Y	Y
P8	N	N	N	N	N	N	Y	Y	Y
P9	Y	Y	Y	Y	Y	Y	Y	Y	Y
P10	Y	Y	Y	Y	Y	Y	Y	Y	Y
P11	Y	N	Y	N	N	N	Y	Y	Y
P12	Y	N	N	N	N	N	Y	Y	Y
P13	N	Y	Y	N	N	N	Y	Y	Y
P14	N	Y	Y	N	N	N	Y	Y	Y
P15	Y	Y	Y	N	N	N	Y	Y	Y
P16	Y	N	N	N	N	N	Y	Y	Y
P17	Y	Y	Y	N	N	N	Y	Y	Y
P18	Y	Y	Y	N	N	N	Y	Y	Y
P19	Y	Y	Y	N	N	N	Y	Y	Y
P20	Y	Y	Y	Y	N	N	Y	Y	Y
P21	N	N	N	N	N	N	Y	Y	Y
P22	Y	N	N	Y	N	N	Y	Y	Y
P23	Y	Y	N	N	N	N	Y	Y	Y
P24	Y	N	N	N	N	N	Y	Y	Y
P25	Y	N	N	N	N	N	Y	Y	Y
P26	Y	Y	Y	N	N	N	Y	Y	Y
P27 TEST ONLY **	N	N	N	N	N	N	N	N	N
P28 TEST ONLY ***	N	N	N	N	N	N	N	N	N

* Serially-controlled 24-inch Legend LGD and Legend LPX only.

@Title 13 LPX is compliant in red

** Pattern 27: All LEDs light head turns on.

*** Pattern 28: Each LED light head sequentially turns on for 1 second.

**** For amber Title 13 compliant models: Selecting the Low Power option makes the flash patterns non-compliant.

It is the user's responsibility to verify the acceptability of Low Power in his or her jurisdiction before using this option.

Table 6 Flash pattern compliances to NFPA

Pattern	NFPA	
	LGD-NFPA***	LPX-NFPA***
P1	N	N
P2	N	N
P3	N	N
P4	N	N
P5	Y	N
P6	Y	N
P7	Y	N
P8	Y	Y
P9	Y	Y
P10	Y	Y
P11	Y	N
P12	Y	N
P13	Y	Y
P14	Y	N
P15	Y	N
P16	Y	N
P17	Y	Y
P18	Y	Y
P19	Y	Y
P20	Y	Y
P21	Y	N
P22	Y	N
P23	Y	Y
P24	Y	Y
P25	Y	Y
P26	Y	N
P27 TEST ONLY **	N	N
P28 TEST ONLY ***	N	N

* Pattern 27: All LEDs light head turns on.

** Pattern 28: Each LED light head sequentially turns on for 1 second.

*** The light bar layout must also meet NFPA compliance. Contact Customer Support for verification at 1-800-682-8022.

Model LPXD Light Activation

The operational mode of the Model LPXD Discrete-Wire Legend is dependent upon the variation of options incorporated into the final model. Installation, wiring, and operation instructions are in the instructions supplies with the Model LPXD. The functions defined in Table 7 are activated via +12 Vdc applied to any of the wires shown in Table 7 except for the green pattern-selection wire, which is ground activated. There are eight flashing patterns available, which are described in Table 8.

Follow the standard installation from the Legend (LGD) instructions. Federal Signal recommends fusing each wired connection in Table 7 with the fuse shown in the table. See Schematic A 7 on page 58.

Table 7 Model LPXD control wires for light activation

Wire Color	Fuse	Light Activation
Red	20 A	Front of light bar, Mode 1 (for rear cutoff, activate only the red wire)
Yellow	20 A	Rear of light bar, Mode 1 (for front cutoff, activate only the yellow wire)
Blue	5 A	Mode 2: Overrides Mode 1
Gray	5 A	Flash takedown/alley
Brown	5 A	Left alley
Brown/White	5 A	Right alley
Orange	5 A	Worklight/takedown (If both options are installed, they work together.)
Green	NA	Pattern change ***THIS FUNCTION IS GROUND ACTIVATED***

Model LPXD Flash Pattern Compliances

The flash patterns listed as “Yes” (Y) in Table 7 comply with the SAE J845 flash requirements and light output requirements. Patterns listed as “No” (N) do not comply with these requirements. A non-compliant pattern should be used only after the people you are trying to warn have been trained to recognize the pattern as a warning signal. End users are responsible for choosing the flash patterns that meet their jurisdiction’s requirements.

Table 8 Model LPXD available flash patterns

Pattern Number	Description	SAE J845 Compliant
P1	2 at 60 FPM QUAD FLASH Alternating, then 2 at 60 FPM DOUBLE FLASH Simultaneous	N
P2	60 FPM 5-FLASH Alternating	Y
P3	60 FPM QUAD FLASH Alternating	Y
P4	75 FPM TRIPLE FLASH Alternating	Y
P5	85 FPM DOUBLE FLASH Alternating	Y
P6	115 FPM Alternating	Y
P7	152 FPM Alternating	Y
P8	1 at 60 FPM TRIPLE FLASH Alternating 2 at 60 FPM TRIPLE PULSE Simultaneous	N

Changing the Default MODE 1 Flash Pattern

To change the Mode 1 flash pattern to one of the patterns shown in Table 8:

1. Apply +12 Vdc power to the red and/or yellow MODE 1 wire(s).
2. Temporarily ground the green wire to advance to the next pattern. Repeat this step until the pattern you want displays.
3. Remove power from the light bar. The pattern is retained as the MODE 1 default.

Changing the Default MODE 2 Flash Pattern

To change the Mode 2 flash pattern to one of the patterns shown in Table 8:

1. Apply +12 Vdc power to the red and/or yellow MODE 1 wire(s).
2. Apply +12 Vdc power to the blue MODE 2 wire.
3. Temporarily ground the green wire to advance to the next pattern. Repeat this step until the pattern you want displays.
4. Remove power from the light bar. The pattern is retained as the MODE 2 default.

Preparing the Legend for Installation

Taking the preparatory steps in this section before mounting and wiring the light bar to a vehicle will help to ensure that your installation is fast, easy, and error free. In addition to bench testing, this section has instructions for changing default settings and flash patterns.

Unpacking the Light Bar

Carefully unpack the light bar assembly and any other products included in the shipment. Inspect them for damage that may have occurred during shipping. If a product has been damaged, do not install or operate it. Immediately file a claim with the carrier describing the damage.

Carefully check all envelopes, shipping labels, and tags before removing or destroying them. If you are missing any parts, contact Customer Support at 1-800-264-3578, 7 AM to 5 PM, Monday through Friday (CT).

Changing the Default Settings

Although the light bar is configured and programmed at the factory, you may want to change default settings and flash patterns before installation. Before you begin, decide if you want to change these default settings:

SignalMaster Operation: Internal (factory default) or External

You can change the setting from Internal to External. INTERNAL operation uses the light bar's on-board SignalMaster controller to generate directional warning patterns. With Internal operation, an external SignalMaster controller is not needed. A standard low-current switch box can activate the internal SignalMaster controller.

EXTERNAL operation uses the Serial Interface Module to drive each SignalMaster directional warning head independently through an external Federal Signal SignalMaster controller or SS2000SM series siren

MODE 1, 2, 3, and INTERSECTION

MODES 1 through 3 are most often selected by a progressive slide switch, which enables the driver to turn on the light bar without looking down. You can select a pattern for each mode from the light bar's library of 26 patterns.

The INTERSECTION flash pattern is typically a high activity pattern that attracts attention to the vehicle as it approaches an intersection. You can select a pattern from the library and choose one of three ways to turn on and off the pattern. The INTERSECTION flash pattern overrides the three priority modes.

NOTE: If the SignalMaster flash pattern is turned on, it overrides the current flash pattern.

FRONT and REAR lights: CUTOFF (default) or ENABLE

Set these options after you change the default settings for MODE and INTERSECTION flash patterns. CUTOFF turns OFF the front or rear LEDs when 12 Vdc is applied to the FRONT or REAR light control wire. ENABLE turns ON the front or rear LEDs when 12 Vdc is applied.

Making the Initial Electrical Connections

NOTICE

REVERSE POLARITY / MISWIRING: Reverse polarity or incorrect voltage may damage the light. To avoid damage to the light, ensure that the battery voltage is the same as the voltage rating of the light and that the correct polarity is observed. If you are connecting to a cigarette lighter plug or 12 V outlet, connect the positive wire to the center terminal and connect the negative wire to the outer terminal.

The Legend does not require any internal wiring. Two 10 AWG power conductors (red and black) and a CAT5 cable exit the light bar. The light bar's basic light functions are communicated through the CAT5 cable, which connects to the Serial Interface Module. (The Discrete-Wired 24-inch Legend does not connect to the Serial Interface Module and has no CAT5 cable.) For wiring schematics, see the Appendix starting on page 52.

To make the electrical connections for reprogramming the light bar:

1. To supply power to the light bar, use a fully-charged 12-volt automotive battery with terminal lugs.
2. Place the light bar on a sturdy, flat surface.
3. Plug the CAT5 communication cable (1) from the light bar into the Serial Interface Module (J1). See Figure 1.

Figure 1 Electrical connections for testing and reprogramming

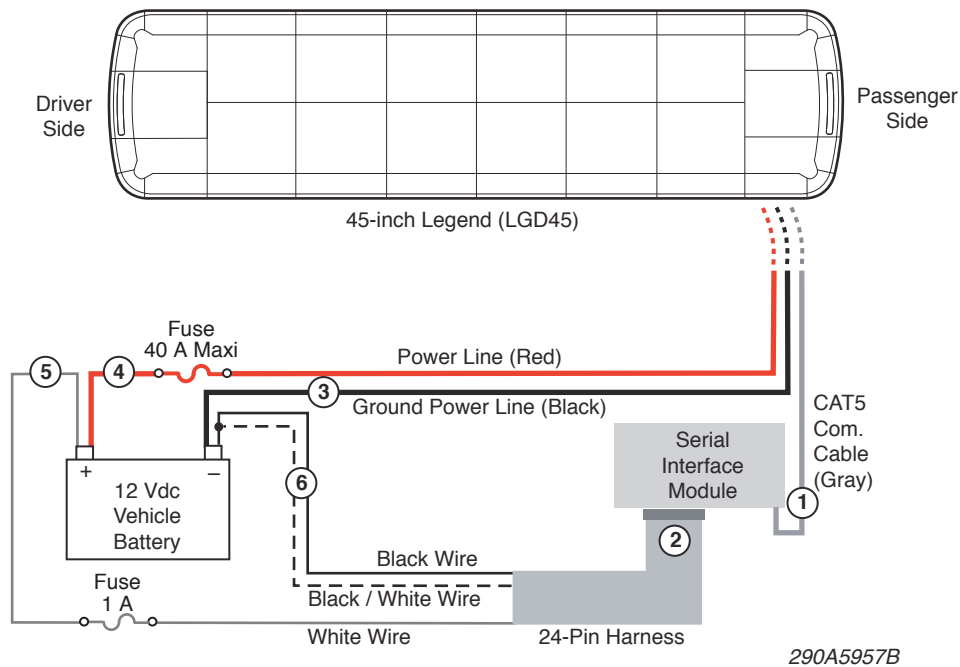

4. Plug the 24-pin harness (2) into the Serial Interface Module.
5. Attach the light bar's black ground power line (3) to the negative battery (–GND) lug.
6. Attach the light bar's red power line (4) through a 40 A MAXI® fuse to the positive battery (+BAT) lug.
7. Attach the white wire (5) from the 24-pin harness through a 1 A fuse to the positive battery (+BAT) lug.
8. Attach the black wire and the black/white wire (6) from the 24-pin harness to the negative battery (–GND) lug.

Control Wires for Flash Patterns

This section describes how to program flash patterns during bench testing and programming by applying 12 Vdc to the control wires in the Serial Interface Module's 24-pin harness. Table 9 shows the control wires and their colors. The wire's first color is the predominant color; additional colors are stripes.

Table 9 Control wires from the Serial Interface Module

Light Bar Controls	Wire Color	Description
MODE 1	Blue	Lowest priority
MODE 2	Blue/White	Overrides MODE 1
MODE 3	Black/Red	Overrides MODES 1 and 2
STEADY BURN (Legend light bar models only)	Red/White	One or more LEDs steadily burn when 12 Vdc is applied to the control wire for a MODE and the control wire for STEADY BURN
FRONT CUTOFF	Green/White	Turns OFF the FRONT of the light bar
FRONT ENABLE		Turns ON the FRONT of the light bar
REAR CUTOFF	Orange/Black	Turns OFF the REAR of the light bar
REAR ENABLE		Turns ON the REAR of the light bar
INTERSECTION	Blue/Black	Typically a high activity pattern. Overrides all three priority modes.
FLASH TAKEDOWN/ ALLEY	Red/Black	Flashes the ALLEY and TAKEDOWN lights in MODES 1, 2, or 3
LEFT ALLEY	Green/Black	Turns on LEFT ALLEY lights. Overrides the FLASH TAKEDOWN/ALLEY lights
RIGHT ALLEY	Orange/Red	Turns on RIGHT ALLEY lights. Overrides the FLASH TAKEDOWN/ALLEY lights.
TAKEDOWN	White/Black	Provides white light to the front. Overrides FLASH TAKEDOWN/ALLEY lights and FRONT CUTOFF.
LOW POWER	White/Black/Red	Dims the lights approximately 50 percent to prevent blinding approaching drivers. LOW POWER is only available in MODES 1 and 2 and is disabled when switched to another flash pattern, including MODE 3 and INTERSECTION.
LIGHT BAR TEST PATTERN	Black/White/Red	Flashes the LEDs sequentially and then flashes the TAKEDOWN and ALLEY lights. Does not test the Steady Burn LEDs.

Switch Settings in the Serial Interface Module

The switches to change default settings and reprogram flash patterns are accessible through openings on the side of the Serial Interface as shown in Figure 2.

Figure 2 Serial Interface Module

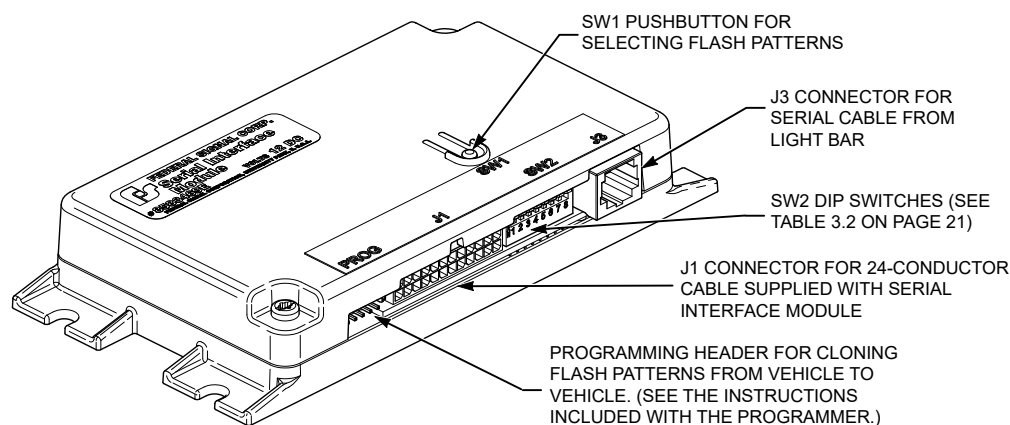

290A7689

Table 10 SW-2 DIP Switch Settings

SW-2 Switch Number	Switch Setting		Function
	Up (OFF)	Down (ON)	
1	X		FRONT/REAR LEDs cut off (turn off) when 12 Vdc is applied to their control wires (Table 9 on page 20)
1		X	FRONT/REAR LEDs enable (turn on) when 12 Vdc is applied to their control wires
2	X		Keep in OFF position
3	X		Keep in OFF position
4		X	SignalMaster, Internal control (factory default)
4	X		SignalMaster, External control
5	X		Cycle forward through the selection of flash patterns
5		X	Cycle backward through the selection of flash patterns
6	X		Operation Mode
6		X	Program Mode
7			Switch for INTERSECTION operational settings (Table 11 on page 24)
8			Switch for INTERSECTION operational settings (Table 11)

Selecting External SignalMaster Control

Internal control is the factory default setting. See Table 10.

To change to External control:

1. Unplug the 24-pin harness from the Serial Interface Module.
2. Move Switch 4 on SW-2 to the up (OFF) position.
3. Plug the 24-pin harness into the Serial Interface Module.

Selecting Internal SignalMaster Control (Factory Default)

To return to External SignalMaster control:

1. Unplug the 24-pin harness into the Serial Interface Module
2. Move Switch 4 on SW-2 to the down (ON) position.
3. Plug the 24-pin harness into the Serial Interface Module.

Entering Program Mode

To switch the module from Operation Mode to Program Mode:

1. Unplug the 24-pin harness from the Serial Interface Module.
2. On the Serial Interface Module, move Switch 6 on SW-2 to the down (ON) position. See Figure 3 on page 25.
3. Plug the 24-pin harness into the Serial Interface Module.

NOTE: When you press and release the SW-1 button on the Serial Interface Module to select a pattern, the light bar briefly turns off and then displays the next pattern. To cycle backwards to a previous pattern, move Switch 5 to ON (up position) on SW-2.

Programming Priority MODES 1, 2, 3, and INTERSECTION

The three modes operate with MODE 3 having the highest priority: MODE 3 overrides MODE 2, and MODE 2 overrides MODE 1. When the light bar operates in one of these modes, the SignalMaster modules keep sequence with the flash pattern. You can change default MODE flash patterns by programming each mode with one of 26 patterns in the light bar's library. A typical setup would be:

- MODE 1: REAR LEDs
- MODE 2: FRONT/REAR LEDs
- MODE 3: Siren (SmartSiren® or Federal Signal compatible), and FRONT/REAR LEDs and FLASH TAKEDOWN/ALLEY LEDs on the mainbar
- MODES 1 and 2: FRONT/REAR CUTOFF

NOTE: If the light bar needs to be programmed after you connect a progressive slide switch, the programming sequence must be MODE 3, MODE 2, MODE 1, INTERSECTION.

Mode 3

1. Apply 12 Vdc (+BAT) to the MODE 3 control wire (black/red) from the Serial Interface Module to display the assigned pattern.
2. On the Serial Interface Module, press and release the SW-1 button until the pattern you want displays on the light bar.
3. Remove 12 Vdc from the MODE 3 control wire.

Mode 2

1. Apply 12 Vdc (+BAT) to the MODE 2 control wire (blue/white) from the Serial Interface Module to display the assigned pattern.
2. On the Serial Interface Module, press and release the SW-1 button until the pattern you want displays on the light bar.
3. Remove 12 Vdc from the MODE 2 control wire.

Mode 1

1. Apply 12 Vdc (+BAT) to the MODE 1 control wire (blue) from the Serial Interface Module to display the assigned pattern.
2. On the Serial Interface Module, press and release the SW-1 button until the pattern you want displays on the light bar.
3. Remove 12 Vdc from the MODE 1 control wire.

Intersection

The INTERSECTION flash pattern overrides all three priority modes when activated. To select a new pattern, you must apply 12 Vdc to the control wire for either MODE 1, 2, or 3 (Table 9 on page 20) and the blue/black control wire for INTERSECTION.

NOTE: This procedure only programs the INTERSECTION pattern. It does not assign the pattern to a MODE.

1. Apply 12 Vdc (+BAT) to a control wire for either MODE 1, 2, or 3, and the control wire for INTERSECTION from the Serial Interface Module.
2. On the Serial Interface Module, press and release the SW-1 button until the pattern you want displays on the light bar.
3. Remove 12 Vdc from the MODE and INTERSECTION control wires.

Intersection Operational Settings

Select one of three options to turn on the INTERSECTION pattern:

- HIGH with +BAT power maintained (default): The light bar displays the INTERSECTION pattern until power is removed.
- TAP II (push-on/push-off): The INTERSECTION flash pattern is turned on and off by pressing a momentary contact switch, such as a horn button. Momentary 12 Vdc turns on the pattern, a second momentary 12 Vdc signal turns it off.
- 8-SECOND TIMEOUT activated by +BAT: Momentary 12 Vdc turns on the INTERSECTION flash pattern for eight seconds.

To change from HIGH to TAP II or 8-SECOND TIMEOUT:

1. Unplug the 24-pin harness from the Serial Interface Module.
2. On the Serial Interface Module, set Switch 7 and Switch 8 on SW-2 to select a method of operation (Figure 2 on page 21 and Table 11.) Each setting is independent of the other.
3. Plug the 24-pin harness into the Serial Interface Module.

Table 11 Switch settings for INTERSECTION operation

Operational Settings	SW-2	
	SW7	SW8
HIGH (+BAT maintained)	OFF (up)	OFF (up)
TAP II (+BAT, push on/push off)	ON (down)	OFF (up)
8-SECOND TIMEOUT (activated by +BAT)	OFF (up)	ON (down)

FRONT/REAR ENABLE or CUTOFF

The operational setting for FRONT/REAR ENABLE or CUTOFF must be programmed after MODE and INTERSECTION. The default setting is for CUTOFF in which the FRONT or REAR LEDs turn off when 12 Vdc (+BAT) is applied to their control wires. In contrast, FRONT/REAR ENABLE turns on these LED modules when +BAT is applied to their control wires. Both FRONT and REAR share the same operational setting and are not independent.

To program for FRONT/REAR ENABLE or CUTOFF:

1. Unplug the 24-pin harness from the Serial Interface Module.
2. On the Serial Interface Module, move Switch 1 on SW-2 to:
 - the down (on) position for Front/Rear Enable.
 - the up (off) position for Front/Rear Cutoff.
3. Plug the 24-pin harness into the Serial Interface Module.

NOTE: When set to ENABLE, 12 Vdc must be applied to a MODE control wire and the FRONT and/or REAR ENABLE control wire for the light bar to operate.

In a typical installation, if you want only the REAR LED modules to flash in MODE 1, set the operation for ENABLE. Connect the green/white and blue/white control wires to the MODE 2 connection and the orange/black and blue control wires to the MODE 1 connection.

Exiting Program Mode

When you are finished programming patterns, switch the Serial Interface Module from Operation Mode to Program Mode.

1. Unplug the 24-pin harness from the Serial Interface Module.
2. On the Serial Interface Module, move SW-2 Switch 6 to the up (OFF) position.

3. Plug the 24-pin harness into the Serial Interface Module.

Figure 3 Light options for Legend light bars

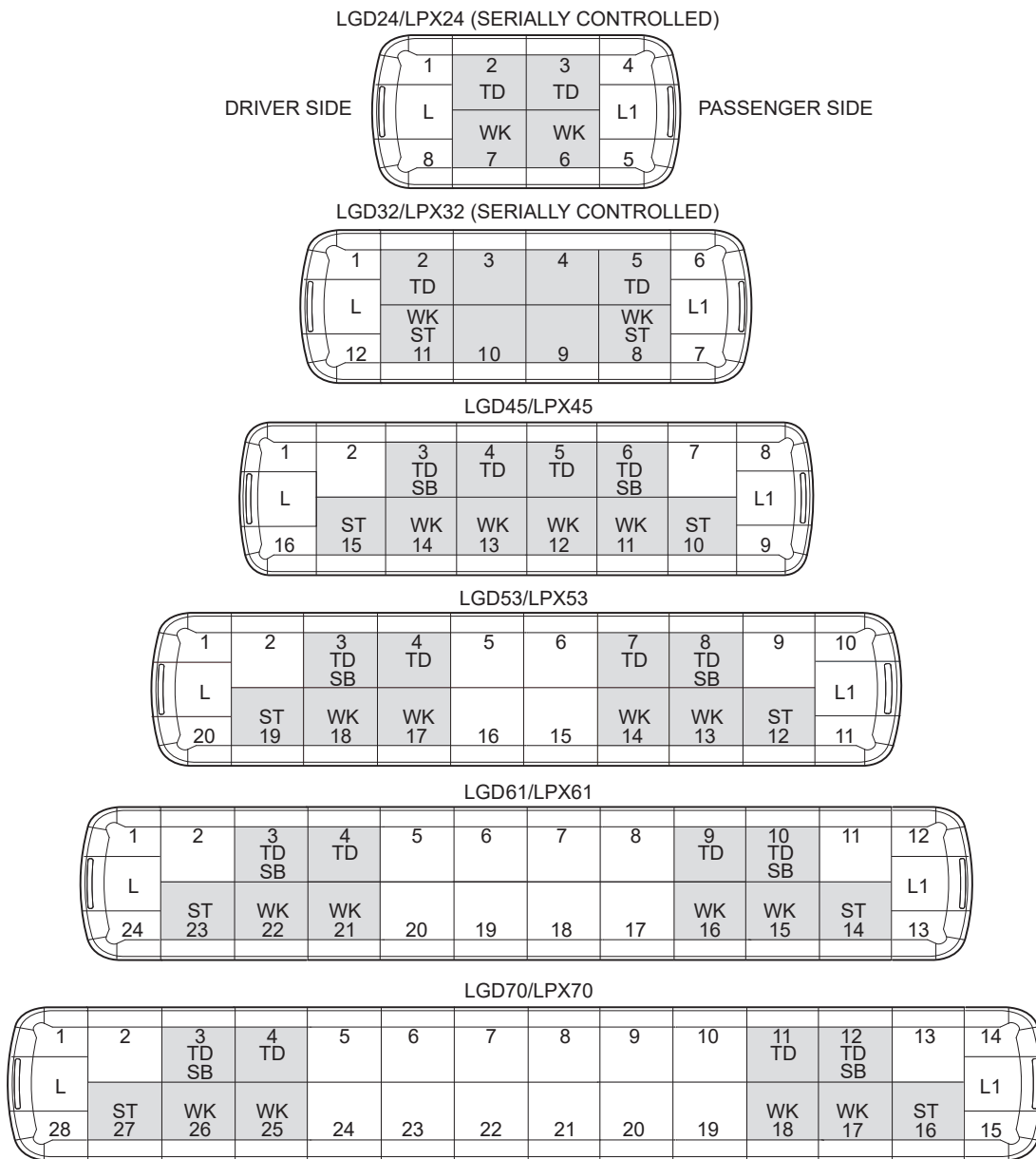

290A5960E

TD = TAKEDOWN WK = WORK LIGHT
 SB = STEADY BURN (Legend only) L, L1 = ALLEY LIGHT
 ST = STOP/TURN/TAIL

SignalMaster LED Positions	
<p>6-HEAD</p> <p>LGD45/LPX45: 10–15</p> <p>LGD53/LPX53: 13–18 (WITH STOP/TURN TAIL LIGHTS IN 12 AND 19)</p> <p>LGD61/LPX61: 16–21 (WITH WORK LIGHTS IN 15 AND 22)</p> <p>LGD70/LPX70: 19–24</p>	<p>8-HEAD</p> <p>LGD53/LPX53: 12–19 (WITHOUT STOP/TURN/TAIL LIGHTS)</p> <p>LGD61/LPX61: 15–22 (WITHOUT WORK LIGHTS)</p> <p>LGD70/LPX70: 18-25 (WITH WORKLIGHTS IN 17 AND 26)</p>

NOTES: LED WARNING LIGHTS OF ANY COLOR CAN FUNCTION AS SIGNALMASTER DIRECTIONAL WARNING LIGHTS, EXCEPT STOP/TURN/TAIL LEDS AND WORK LIGHTS.
 STEADY-BURN OPTION IS AVAILABLE ONLY IN LEGEND LIGHT BAR MODELS.

Wiring the Legend in the Vehicle

Before wiring the light bar in the vehicle, mount the light bar according to the instructions included with the mounting kit.

The light bar is completely wired at the factory and does not need any additional internal wiring. For typical installations with common control systems, see the wiring schematics in the Appendix starting on page 52. The basic light functions of the light bar must be controlled by a user-supplied control panel.

Wiring the Light Bar in the Vehicle

⚠ WARNING

AIRBAG DEPLOYMENT: *Do not install equipment or route wiring in the deployment path of an airbag. Failure to observe this warning will reduce the effectiveness of the airbag or potentially dislodge the equipment, causing serious injury or death.*

⚠ WARNING

SEAT REMOVAL PRECAUTION: *If a vehicle seat is temporarily removed, verify with the vehicle manufacturer if the seat needs to be recalibrated for proper airbag deployment. Failure to follow this warning cause serious injury or death.*

⚠ WARNING

BATTERY EXPLOSION: *To avoid a battery explosion, always disconnect the negative battery cable first and reconnect it last. Avoid causing a spark when connecting near or to the battery. The gases produced by a battery can cause a battery explosion that could result in vehicle damage and serious injury.*

To wire the light bar:

1. Ensure that the lines are adequately fused as shown in the wiring schematics in the Appendix starting on page 52. From the light bar, route the CAT5 control cable into the vehicle's cab or trunk near the eventual location of the Serial Interface Module. An input cable is also provided with the Interface Module.

NOTICE

REVERSE POLARITY / MISWIRING: *Reverse polarity or incorrect voltage may damage the light. To avoid damage to the light, ensure that the battery voltage is the same as the voltage rating of the light and that the correct polarity is observed. If you are connecting to a cigarette lighter plug or 12 V outlet, connect the positive wire to the center terminal and connect the negative wire to the outer terminal.*

2. Route and connect the light bar's black lead to the vehicle battery's ground (-GND) terminal.

3. Route and connect the light bar's red lead through a 40 A MAXI[®] fuse and fuse holder (or equivalent) at the source, which is the positive battery terminal (+BAT).

Mounting the Serial Interface Module

The Serial Interface Module communicates between a user-supplied light bar/siren controller, a SignalMaster controller, or a switch box and the Legend. To minimize the number of discrete wires to the light bar, control lead functions are wired to the Interface Module through a 3-foot long, 24-conductor cable harness (Table 9 on page 20). The information is converted to a digital format and communicated to the light bar through the CAT5 serial communication cable. (The discrete-wired 24-inch Legend does not connect to the Serial Interface Module.)

⚠ WARNING

LOCATION OF LIGHT SYSTEM CONTROLS: *Locate light system controls so that VEHICLE and CONTROLS can be operated safely under all driving conditions.*

NOTE: If you are using the External SignalMaster option, you must configure the Serial Interface Module for External operation before installing it as described in "Selecting External SignalMaster Control" on page 21.

NOTICE

UNIT REQUIRES SHELTER FROM WEATHER: *The Serial Interface Module is NOT waterproof. It must be mounted in a location that is sheltered from rain, snow, standing water, etc.*

NOTICE

UNIT REQUIRES VENTILATION: *The Serial Interface Module needs to radiate heat. Do not install it in an area where it cannot dissipate heat into the air. Do not mount it near a heater duct.*

IMPORTANT: The Serial Interface Module must be installed within 36 inches (91 cm) of the light bar controller.

1. Use the Serial Interface Module as a template and scribe four drill position marks at the selected mounting location. Mounting centers are 2 by 5.95 inches (5.08 cm x 15.11 cm)

NOTICE

DRILLING PRECAUTIONS: *Before drilling holes, check the area into which you plan to drill to ensure that you do not damage vehicle components. All drilled holes should be deburred and all sharp edges should be smoothed. Additionally, all exterior drilled holes must be sealed with Motorcraft seam sealer T-A-2-B or equivalent to prevent the potential exposure to carbon monoxide or other potentially harmful fumes. Failure to observe this warning could cause serious injury or death.*

⚠ WARNING

DRILLING PRECAUTIONS: DO NOT drill holes in ANY part of the Serial Interface Module. Damage to the unit, serious injury, or death may result.

2. Drill four mounting holes at the drill position marks, sized for the recommended user-supplied #8 mounting hardware.
3. Secure the Serial Interface Module to the mounting surface with user-supplied #8 mounting hardware.
4. Install the light bar's CAT5 serial cable to the J3 output jack of the Serial Interface Module.
5. Install the three-foot-long, 24-conductor cable to the J1 input connector of the Serial Interface Module.

⚠ WARNING

SHOCK HAZARD: Strobe and HID light systems generate high voltages. Disconnect power from the system and wait at least 5 minutes before opening the unit. Do not apply power to the unit while the unit is open. Failure to follow this warning could result in serious injury or death.

NOTE: Powering multiple devices with a common control wire may cause one or more devices to briefly remain functional after signal power is removed. For example, due to the high input filter capacitance, a strobe supply can briefly supply the current required to signal a light bar function to remain ON. If necessary, use a relay to isolate devices with large filter capacitors. See Figure 4. All components/wires are user-supplied.

Figure 4 Relay-isolating devices with large filter capacitors

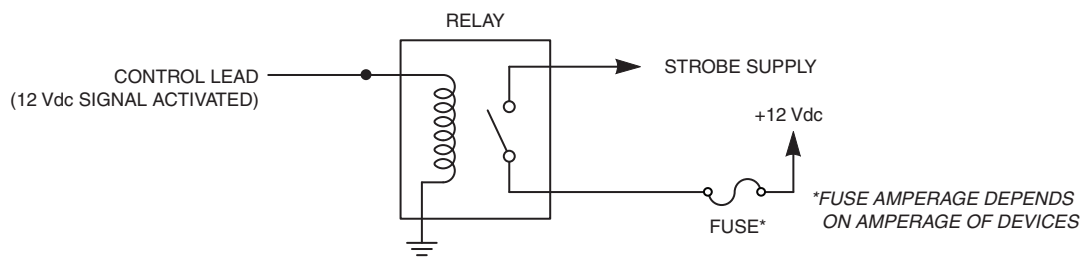

290A5976

NOTE: After installation, check the entire system to ensure that the lights are flashing properly and that all light system functions are operating properly.

Wiring the Serial Interface Module

For the wiring block diagram, see Figure 5.

Figure 5 Wiring block diagram

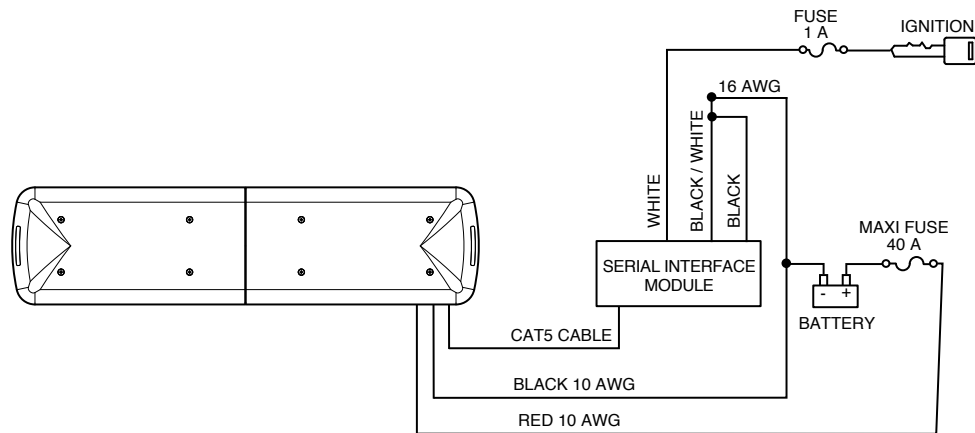

290A5977

NOTICE

FUSE ELECTRICAL SOURCES: Always fuse current/voltage sources with a fuse connected near the power source. Ensure that the fuse is properly rated to protect the electrical load, the wiring, and the connectors used in the circuit. Failure to follow this notice could result in vehicle or equipment damage.

For typical installations with common controllers and switch boxes, see the wiring schematics in the Appendix starting on page 52.

For wiring the controller's functions to the Serial Interface Module's 24-pin cable harness, see Table 9 on page 20 and the figures on pages 32 through 34. If additional wire is necessary for the harness (except ground), 22 AWG wire is adequate. The ground wires must be extended with 16 AWG or better wire.

This section is an overview of default settings that are activated when connecting LED and MODE control wires to 12 Vdc (+BAT). All programming and changes to default settings should be done after bench testing the light bar and before installation. Programming is covered in "Programming Priority MODES 1, 2, 3, and INTERSECTION" on page 22. For a description of the control wires from the Serial Interface Module, see Table 9 on page 20.

MODES 1, 2, and 3

To activate a mode, apply 12 Vdc (+BAT) to a mode control wire. MODE 3 overrides MODE 2, and MODE 2 overrides MODE 1. You can program one of the 26 flash patterns in the light bar's library to each mode input.

STEADY BURN (LGD Models Only)

When the light bar is equipped with one or more STEADY BURN LED modules, applying 12 Vdc (+BAT) to the STEADY BURN control wire (red/white) turns on the LEDs when any MODE input is selected.

The STEADY BURN LEDs are factory configured per the customer order for one of these options:

- No STEADY BURN (the LEDs flash with the pattern)
- Driver's side STEADY BURN
- Driver's and passenger's side STEADY BURN

FRONT CUTOFF*

When 12 Vdc (+BAT) is applied to the FRONT CUTOFF control wire, the selected MODE operation is deactivated to the front of the light bar. Only the rear LEDs function. Additionally, with FLASH TAKEDOWN/ALLEY active, only the ALLEY lights turn on.

REAR CUTOFF*

When 12 Vdc (+BAT) is applied to the REAR CUTOFF control wire, the selected MODE operation is deactivated to the rear of the light bar. Only the FRONT LEDs flash.

NOTE: The operational setting for FRONT and REAR CUTOFF are not independent. The default setting is for 12 Vdc (+BAT) to be applied for the light bar's front and rear light heads to turn them off (CUTOFF). To change the default setting to turn on these LEDs when 12 Vdc is applied (ENABLE), see "FRONT/REAR ENABLE or CUTOFF" on page 23.

INTERSECTION

When 12 Vdc (+BAT) is applied to the INTERSECTION control wire and a MODE control wire, it turns on the INTERSECTION pattern. When 12 Vdc is removed, the light bar returns to its previous state.

FLASH TAKEDOWN/ALLEY

When 12 Vdc (+BAT) is applied to the FLASH TAKEDOWN/ALLEY control wire and a MODE control wire, the TAKEDOWN and ALLEY lights flash.

LEFT and RIGHT ALLEY Lights

When 12 Vdc (+BAT) is applied to the LEFT or RIGHT ALLEY control wire, the appropriate ALLEY LEDs turn on. The LEFT and RIGHT ALLEY lights override the FLASH TAKEDOWN/ALLEY lights.

TAKEDOWN Lights

When 12 Vdc (+BAT) is applied to the TAKEDOWN control wire, the TAKEDOWN LEDs turn on. TAKEDOWN overrides FLASH TAKEDOWN/ALLEY and FRONT CUTOFF.

WORKLIGHTS

When 12 Vdc (+BAT) is applied to the WORKLIGHT control wire, the WORKLIGHT LEDs turn on.

LOW POWER

⚠ WARNING

LOW LIGHT HAZARD: *Enabling the Low Power function in the light bar may cause the light output to fall below certain current light output standards and guidelines for emergency warning lights. Use extreme caution when using this function. Ensure that the ambient light conditions are low enough that you are seen and that the reduction of glare from the light bar is safer than full light output in the situation. Failure to heed this warning may result in serious injury or death to you or others in your vicinity.*

NOTE: Low power mode is disabled when the light bar is in MODE 3 or displaying the INTERSECTION flash pattern.

When 12 Vdc (+BAT) is applied to the LOW POWER control wire, the LEDs are dimmed to approximately 50 percent of their full brightness. LOW POWER is only functional in MODE 1 or MODE 2. LOW POWER is disabled when switching to another flash pattern, including INTERSECTION. To use LOW POWER again, disconnect 12 Vdc from the LOW POWER control wire and reapply 12 Vdc to the LOW POWER control wire after a change in flash pattern occurs.

IGNITION

Connect the white wire from the supplied J1 cable harness on the Interface Module to a 1 A fuse. Connect the fuse end as close as possible to switched ignition power. Power should also be present in the cranking position.

Connect the black and black/white wire from the 24-pin cable harness on J1 from the Serial Interface Module to battery ground (–GND). Use 16 AWG wire to extend the cable length.

SignalMaster Connections

If SignalMaster operation is not activated by a control head or external controller, the SignalMaster LED heads flash with the selected priority mode (MODE 1, 2, or 3) of operation.

Internal SignalMaster

Internal operation (factory default setting) uses the light bar's built-in SignalMaster controller to generate directional warning patterns. With internal operation, an external SignalMaster controller is not needed. A standard low current switch box can activate the light bar's internal SignalMaster controller.

For the jumper setting in the Serial Interface Module, see "Selecting Internal SignalMaster Control (Factory Default)" on page 21. To activate the light bar's internal SignalMaster controller, apply 12 Vdc (+BAT) to the SignalMaster control wires.

External SignalMaster

External operation uses the Serial Interface Module to drive each SignalMaster directional warning head independently through an external Federal Signal

SignalMaster controller or SS2000SM series siren. (See Figures 6 and 7.) Either device provides an independent ground signal to turn on each head. To cross reference external SignalMaster wiring to a Federal Signal controller or the SM2000SM series siren, see Table 12.

Table 12 Cross reference for controller leads

24-Pin Harness from the Serial Interface Module	SignalMaster* Wire (Figure 6)	SS2000SM* Wire (Figure 7)
Red	White	White (1)
Green	Brown	Brown (2)
Green/Black/White	Green	Green (3)
Orange/Green	Orange	Orange (4)
Orange	Purple	Purple (5)
Blue/Red	Gray	Gray (6)
Red/Green	Yellow	Yellow (7)
White/Red	Blue	Blue (8)

*Wire colors as described in the controller's installation instructions.

Figure 6 SignalMaster 331105 controller (External)

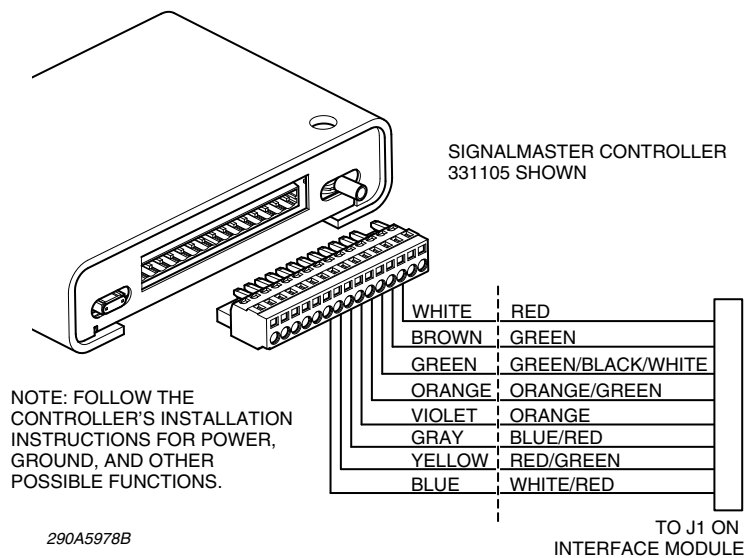

Figure 7 SmartSiren SS2000SM Series controller (External)

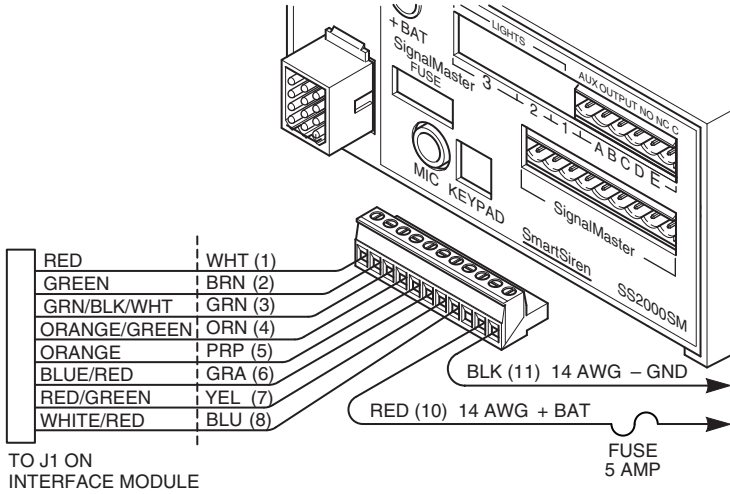

Figure 8 SignalMaster control functions wired to 12 Vdc for Internal control (factory default)

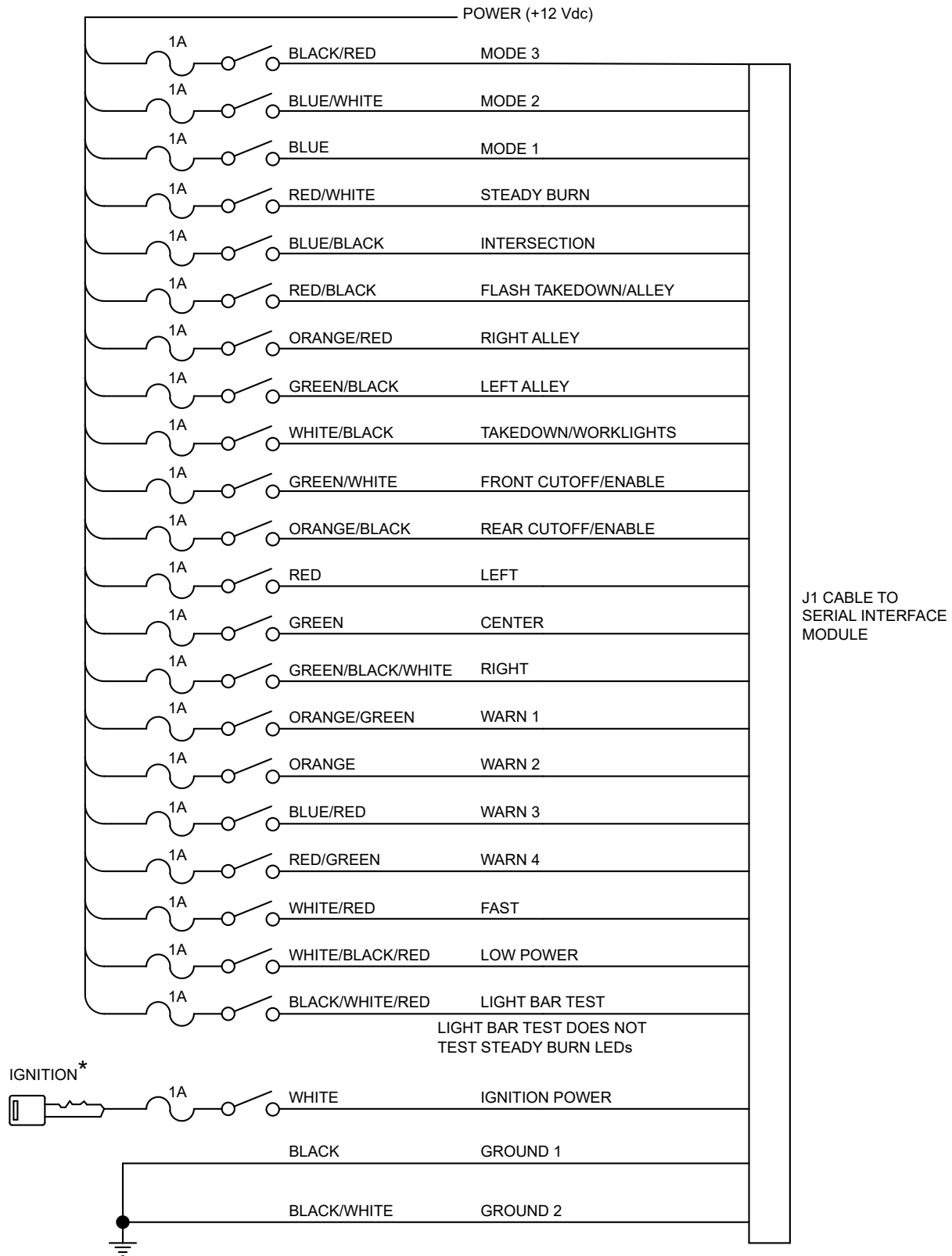
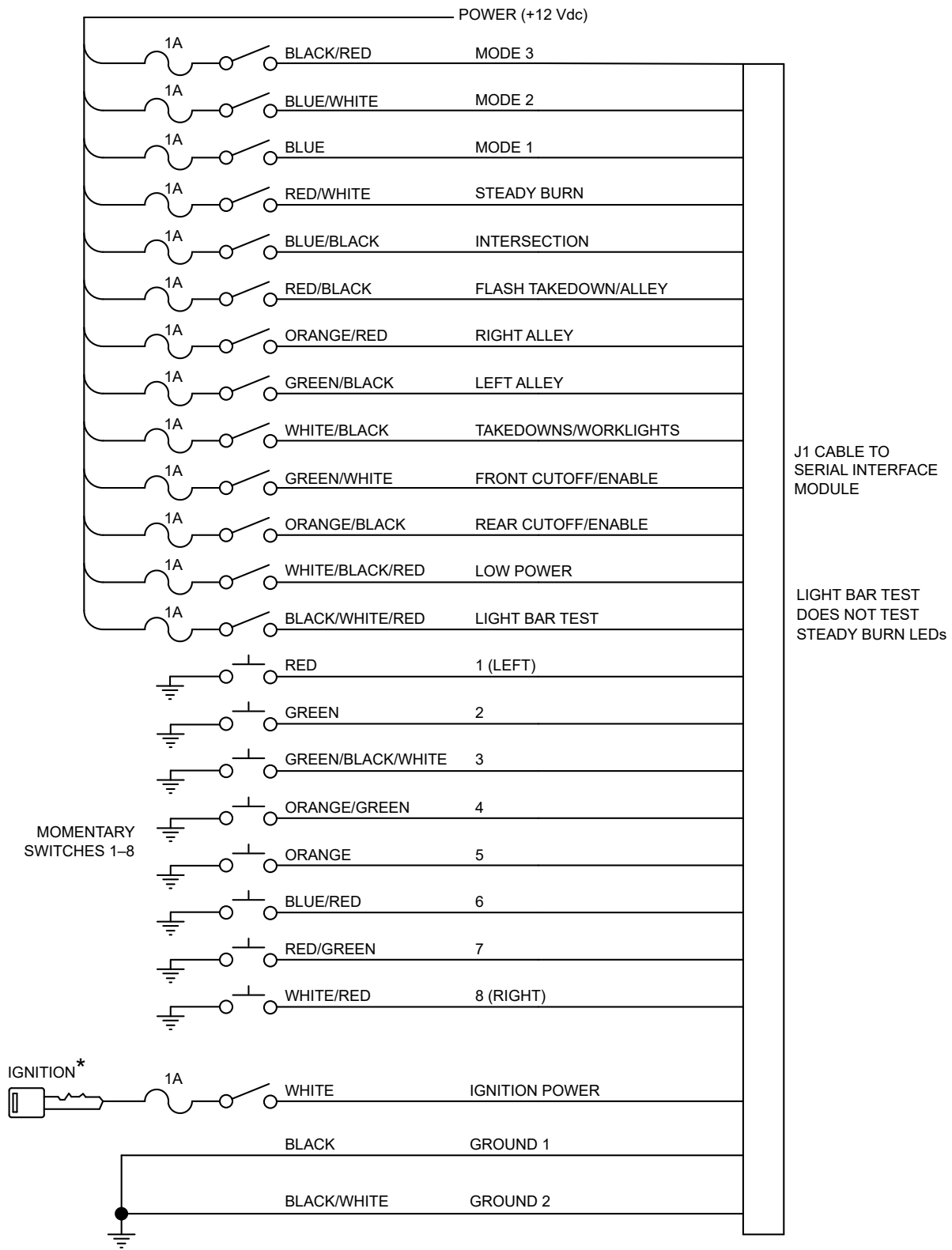

Figure 9 SignalMaster control functions wired to ground for External control



* IGNITION POWER INCLUDES POWER IN THE CRANKING POSITION

290A5980B

Wiring the Stop/Turn/Tail Lights

The light bar's stop/turn/tail lights are a factory-configured option. The light bar is shipped with the option's three-conductor cable ready for splicing into the vehicle harness. For the location of the lights, see Figure 3 on page 25.

⚠ WARNING

QUALIFICATIONS: *To properly connect a stop/tail/turn light, you must have a good understanding of automotive mechanical and electrical procedures and systems along with proficiency in the installation and service of safety warning equipment. Always refer to the vehicle's service manuals when performing equipment installations on a vehicle.*

⚠ WARNING

BATTERY EXPLOSION: *To avoid a battery explosion, always disconnect the negative battery cable first and reconnect it last. Avoid causing a spark when connecting near or to the battery. The gases produced by a battery can cause a battery explosion that could result in vehicle damage and serious injury.*

After mounting and wiring the light bar to the vehicle, follow these steps to wire the light bar's stop/turn/tail lights:

1. Disconnect the vehicle battery's negative ground cable, and then the positive cable.
2. Locate the three-conductor cable exiting the light bar with red, black, and green wires.

NOTE: If installing the option in a vehicle that has its turn signal lights separate from its brake lights, you must purchase a tail light converter.

3. Splice the appropriate cables into the vehicle's wiring. See Figure 10. The input leads require a positive (+) 12 Vdc signal to activate.
4. Reconnect the battery's positive terminal, and then the negative terminal.
5. Test to verify that the light bar's stop/turn/tail lights turn on and off with the vehicle's stop/turn/tail lights.

Figure 10 Stop/turn/tail wiring between light bar and vehicle harness

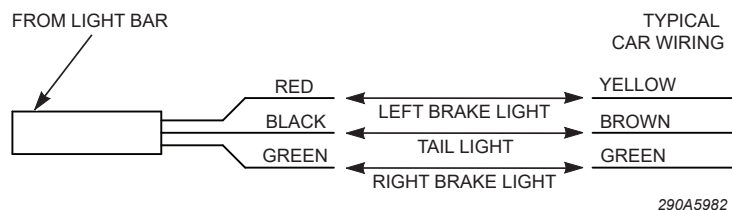

Wiring the Takedown or Worklights (LGD24 or LGD32 Models Only)

The light bar’s worklights are a factory-configured option. The light bar is shipped with the option’s three-conductor cable ready for splicing into the vehicle harness. For the location of the lights, see Figure 3 on page 25.

⚠ WARNING

BATTERY EXPLOSION: To avoid a battery explosion, always disconnect the negative battery cable first and reconnect it last. Avoid causing a spark when connecting near or to the battery. The gases produced by a battery can cause a battery explosion that could result in vehicle damage and serious injury.

To wire the takedown lights or worklights:

1. Disconnect the vehicle battery’s negative ground cable, and then the positive cable.
2. Locate the three-conductor cable exiting the light bar with red, black, and green wires.
3. Connect the wires to switched 12 Vdc positive signals to activate. See Figure 11.

Figure 11 Worklight wiring between light bar and switched +12 Vdc

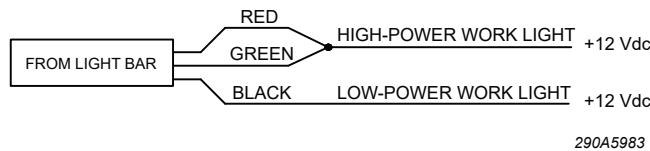

NOTE: High Power Mode overrides the Low Power Mode. If both lines are activated, the worklights come on in High Power Mode. Low Power Mode dims the light bar to 50 percent of full brightness.

4. Reconnect the battery’s positive terminal, and then the negative terminal.
5. Test the light bar to verify that it operates properly.

Wiring for 12-inch Legend

The 12-inch Legend model is available with either an internal flasher that randomly flashes the two light heads, or an external flasher that simultaneously flashes the two light heads.

Figure 12 Internal/External flasher wiring for 12-inch Legends

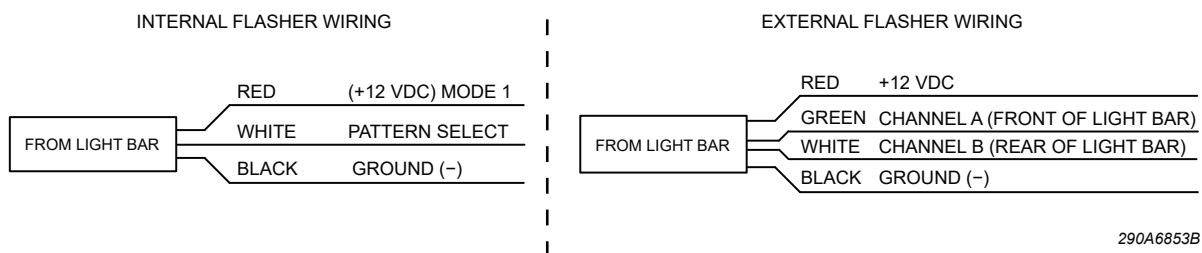

Maintaining and Servicing the Legend

⚠ WARNING

QUALIFICATIONS: *To properly service a light assembly, you must have a good understanding of automotive electrical procedures and systems along with proficiency in the installation and use of safety warning equipment.*

Establishing a regular maintenance schedule for the Legend extends the life of the light bar and ensures safety. Periodically check that the light bar operates properly and that all mounting hardware is securely fastened to the vehicle. Inspect the domes and lenses for cracks, crazing (hairline cracks), discoloration, and other defects.

For service, support, or replacement parts, contact the Federal Signal Service Department at 1-800-433-9132, 7 a.m. to 5 p.m., Monday through Friday (CT).

⚠ WARNING

BATTERY EXPLOSION: *To avoid a battery explosion, always disconnect the negative battery cable first and reconnect it last. Avoid causing a spark when connecting near or to the battery. The gases produced by a battery can cause a battery explosion that could result in vehicle damage and serious injury.*

⚠ WARNING

BURN HAZARD: *After prolonged operation, the unit gets hot and can cause burns. Do not touch the unit while or shortly after it has been operating. Always allow the unit to cool before handling it.*

Servicing the Light Bar Domes

Servicing the light bar domes includes removing them and inspecting their seals and hardware to ensure that the domes remain secure and watertight. Inspection also involves checking the domes for cracks, crazing (hairline cracks) and other defects. For replacement parts, see Table 15 on page 51.

NOTICE

STATIC SENSITIVE DEVICE: *This light bar circuitry can be damaged by electrostatic discharge (ESD). Follow anti-static procedures when servicing this light bar.*

NOTICE

DO NOT OVERTIGHTEN: *To prevent damage to the light bar, do not overtighten the screws or nuts.*

Table 13 Domes and ROC panel assemblies for LGD/LPX models

Model	Domes	ROC Panels
LGD24/LPX24	Driver Side Passenger Side	Two End
LGD32/LPX32	Driver Side Center Passenger Side	Two End One Center
LGD45/LPX45	Driver Side Passenger Side	Two End Two Intermediate
LGD53/LPX45	Driver Side Center Passenger Side	Two End One Center Two Intermediate
LGD61/LPX61	Driver-Side Center 1 Center 2 Passenger Side	Two End Two Center Two Intermediate
LGD70/LPX70	Driver-Side Center 1 Center 2 Center 3 Passenger Side	Two End Three Center Two Intermediate

Removing and Inspecting the Domes

To remove and inspect the domes:

1. Remove the 1/4-20 Phillips-head barrel nuts securing the dome, then carefully remove the dome to avoid damaging the lip seal. See Figure 13.
2. Verify that an O-ring is under the head of each barrel nut and not stuck to the dome. Use a wooden or plastic pick to carefully remove the O-rings from the dome to prevent damaging them.
3. Inspect the O-rings and the lip seal for deformation, brittleness, cuts, or tears. To maintain watertightness, replace a questionable O-ring or seal.
4. Inspect the dome for cracks, crazing (hairline cracks), discoloration, and other defects. Replace defective domes. For replacement parts, see Table 15 on page 51.

Figure 13 Four barrel nuts in passenger-side end dome

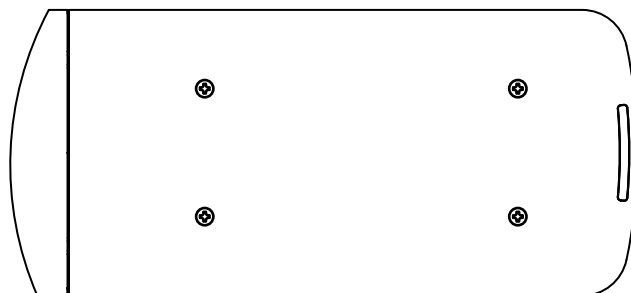

290A5984

Reinstalling the Domes

To reinstall a dome:

1. Place the dome over the ROC panel, ensuring that it is properly seated in the lip seal.

NOTICE

DO NOT OVERTIGHTEN: To prevent damage to the light bar, do not overtighten the screws or nuts.

2. To prevent cross-threading, turn the barrel nuts counterclockwise until you hear a click, then tighten them.

Replacing a Light Bar Base

The light bar's bases secure and protect the LED circuit boards and controller. Regularly inspect them for loose hardware, cracks and weather-tightness. For replacement parts, see Table 15 on page 51.

To replace a base:

1. Remove the domes and ground connection.
 - a. Remove the light bar's domes as described in "Removing and Inspecting the Domes" on page 39.
 - b. Invert the PCB and remove the 5/16-inch hex bolt and ground wire from the aluminum extrusion.
 - c. Note and record the connections, and then disconnect the wires and harnesses.
 - d. Remove the base retainer screw and the cable clamp on the cable entry side.
2. Remove the base.
 - **If the light bar is on the vehicle:** Slide the base from the aluminum extrusion, catching the carriage bolts as they are freed from the channels.
 - **If the light bar is off the vehicle:** Invert the light bar on soft rags or cardboard to protect the domes, then slide the base from the aluminum extrusion. The carriage bolts can then be removed from base

Figure 14 Base removed from aluminum extrusion

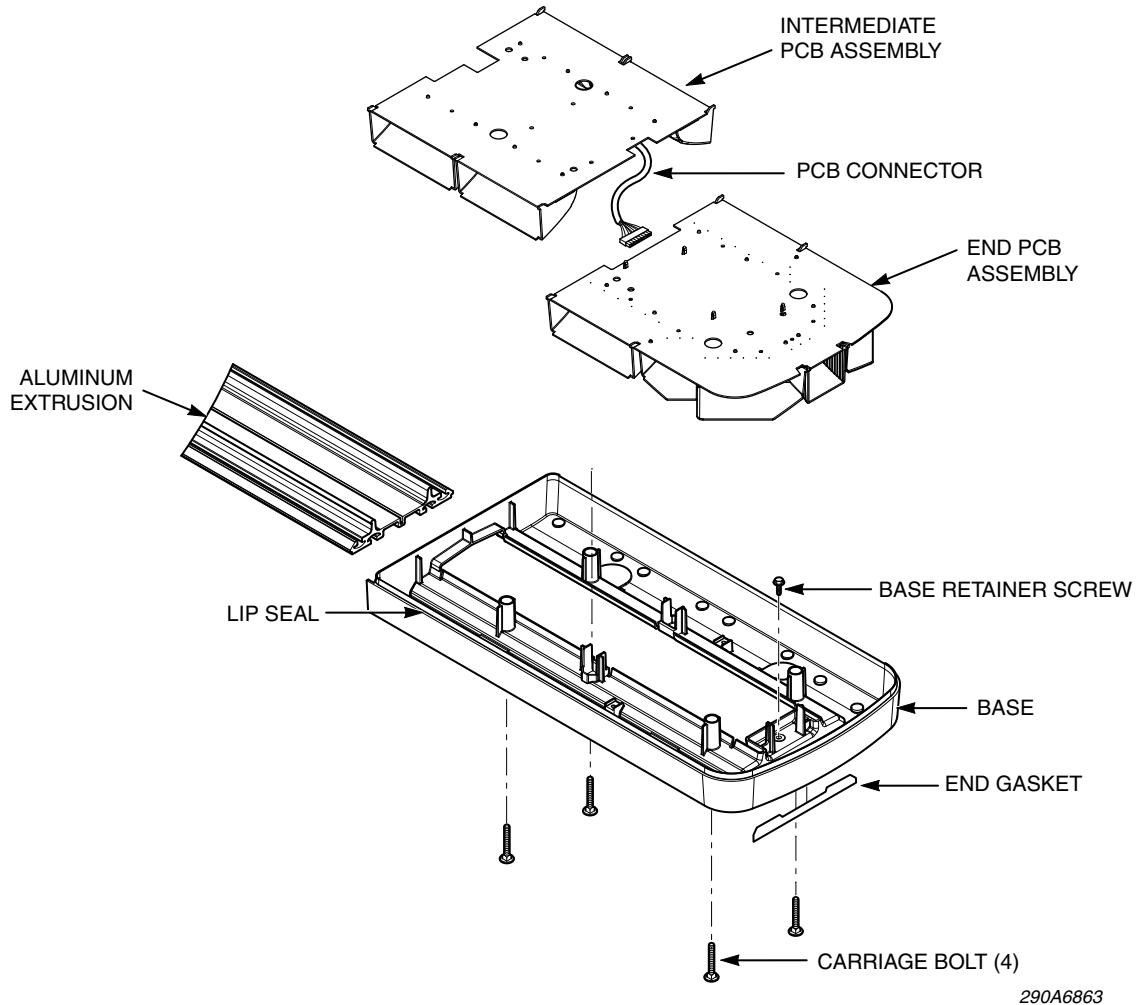

3. Remove the vent plugs and/or grommets from base(s) if applicable.
4. Reinstall the new base with the vent plugs and/or grommets from the previous base(s).

NOTICE

DO NOT OVERTIGHTEN: To prevent damage to the light bar, do not overtighten the screws or nuts.

- a. Make sure the new base has a new end gasket and lip seal. See "Replacing an End Gasket" on page 42 and "Replacing a Lip Seal" on page 42.
- b. **If the light bar is on the vehicle:** Start the base onto extrusion, insert the first two long carriage bolts into their wells, then hold the bolts up while sliding the base further onto the extrusion. Repeat this procedure with the two remaining long carriage bolts. The top barrel nuts may be temporarily installed to hold the bolts in position.

If the light bar is off the vehicle: With the light bar inverted, start the base onto extrusion, and then drop the carriage bolts into each of their wells.

5. Slide the base onto the extrusion. For a flush fit between the bases, apply pressure to the ends of the outer bases and tighten the base retainer screw.
6. Reinstall the PCBs.
 - a. Reconnect the cable clamp on the cable entry side.
 - b. Reconnect the wires and harnesses and invert the PCB on the plastic standoffs. Ensure that the ground wire is not caught between the edges of the PCBs.
 - c. Reconnect the ground wire(s) to the aluminum extrusion using the 5/16-inch hex bolt(s) removed in step 1.b. on page 40. Do not overtighten the bolts.
7. Reinstall the domes as described in "Reinstalling the Domes" on page 40.

Replacing an End Gasket

The end gaskets cushion the aluminum extrusion against the end of the end bases for a snug fit. Check the end gaskets for cracks, tears, or brittleness.

To replace the gasket:

1. Remove the old gasket from inside the end base.
2. Peel the paper backing from the new gasket.
3. Center the gasket in the end of the cavity in the end base.
4. Press the gasket along its length so that it adheres evenly.

Figure 15 End gasket in the end base cavity

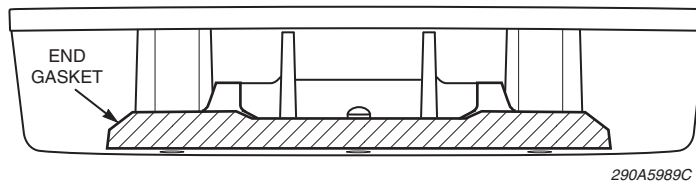

Replacing a Lip Seal

Check the lip seals for cracks tears, or brittleness.

To replace the seal:

1. Remove the light bar's domes as described in "Removing and Inspecting the Domes" on page 39.
2. Note the joint position of the seal, then remove the old lip seal.
3. Install the seal with the fins angled downward as shown in Figure 16, positioning the joint in the same position as original (slightly off-center along the straight surface where the bases mate). The edge of the seal should be flush with the top surface.

Figure 16 Lip seal on edge of plastic dome

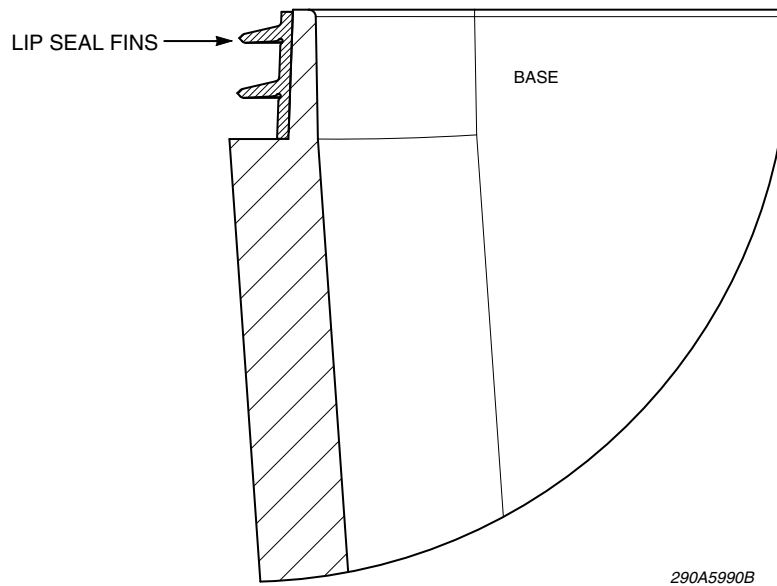

Adjusting the Aim of the HotFoot LED Assemblies (LGD45 and LGD53 Only)

You can horizontally adjust the aim of the LED assemblies by positioning them straight, at 45 degrees or at 90 degrees. Each position has ± 10 degrees of adjustment.

Figure 17 Adjusting the aim of the LED assembly

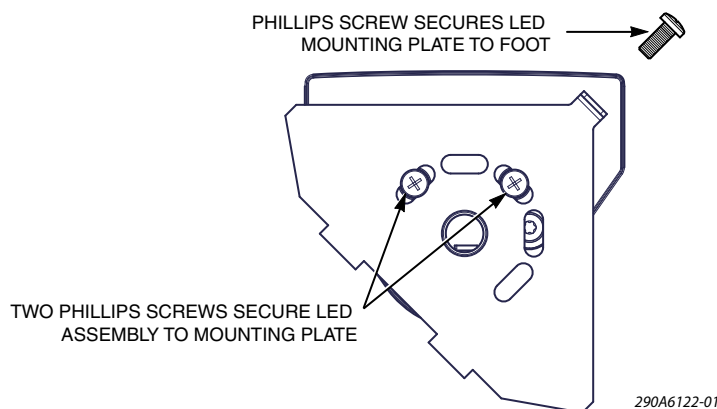

To adjust the aim of the HotFoot LED assemblies:

1. Remove the Phillips Plastite® screw that secures the LED mounting plate to the foot. See Figure 17 on page 43.
2. Lift and slide the LED assembly off the foot just far enough to invert the assembly.
3. Loosen (or remove for a major adjustment) both Phillips Plastite screws securing the LED assembly to the mounting plate.

4. Rotate the LED assembly to the selected position.

NOTICE

DO NOT OVERTIGHTEN SCREWS: To avoid damage to the HotFoot assembly, do not over tighten the screws.

5. Tighten both Phillips Plastite screws securing the LED assembly to the mounting plate.
6. Secure the mounting plate to the foot by tightening the Plastite screw.

Replacing the ROC Panel Assemblies

To replace the ROC panel assembly:

1. Remove the dome over the panel as described in "Removing and Inspecting the Domes" on page 39.
2. Remove the 1/4-inch bolt and disconnect the black ground wire.
3. Invert the ROC panel, note and record the connections, and then disconnect the wires and harnesses.
4. If required, remove the controller as described in "Removing the Controller" in the next section.
5. On the replacement ROC panel, connect the wires and harnesses.
6. Reinstall the controller if necessary, as described in "Reinstalling the Controller" on page 46.
7. Turn the ROC panel over and connect the ground wire using the 1/4-inch hex bolt removed in step 2.
8. Reattach the dome as described in "Reinstalling the Domes" on page 40.

Servicing the Light Bar Controller

The controller generates and receives the signals that control the light bar's flash patterns. If the light bar fails, the problem may be one or more blown fuses. To replace a fuse, you can remove the controller from the aluminum extrusion without completely disconnecting it.

NOTICE

STATIC SENSITIVE DEVICE: This light bar circuitry can be damaged by electrostatic discharge (ESD). Follow anti-static procedures when servicing this light bar.

Removing the Controller

To remove the controller:

1. Remove the passenger-side end dome as described in "Removing and Inspecting the Domes" on page 39.

2. Remove the 1/4-inch hex bolt and disconnect the black ground wire.
3. Invert the panel to expose the controller.
4. Note and record connections, and then disconnect the wires and harnesses.
5. Compress the lock tab on the nylon standoffs and remove controller with its standoffs from ROC panel.
6. Compress the secondary lock tabs and remove the standoffs from controller.

Figure 18 Controller and standoffs removed from ROC panel

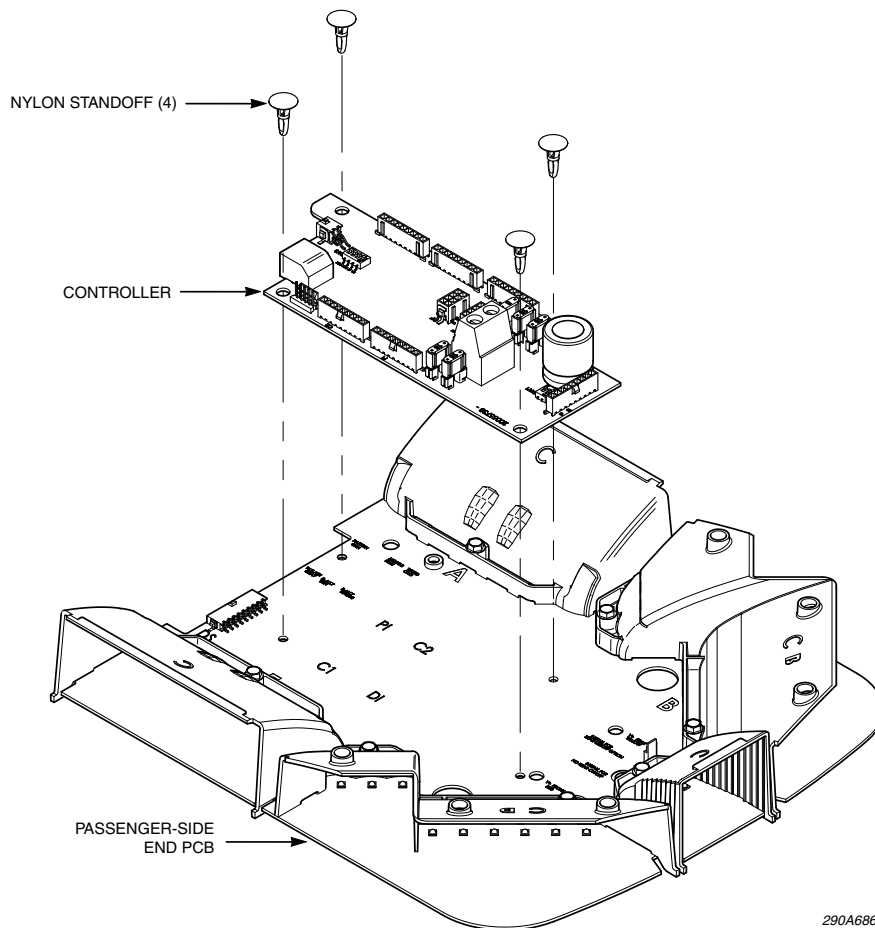

Replacing the Controller Fuses

To replace the controller fuses:

1. The light bar controller has four 15A fuses and one 5A fuse. To see if a fuse is bad, inspect the horseshoe-shaped wire on its side to see if it has burned through and broken the circuit. See Figure 19 on page 46. For replacement fuses, see Table 15 on page 51.
2. To remove a fuse, pull it straight out to avoid damaging the connector.

3. Gently press a new fuse of the same type and amperage into the connector. Ensure that all pins are properly seated.

Figure 19 Fuses on light bar controller PCB

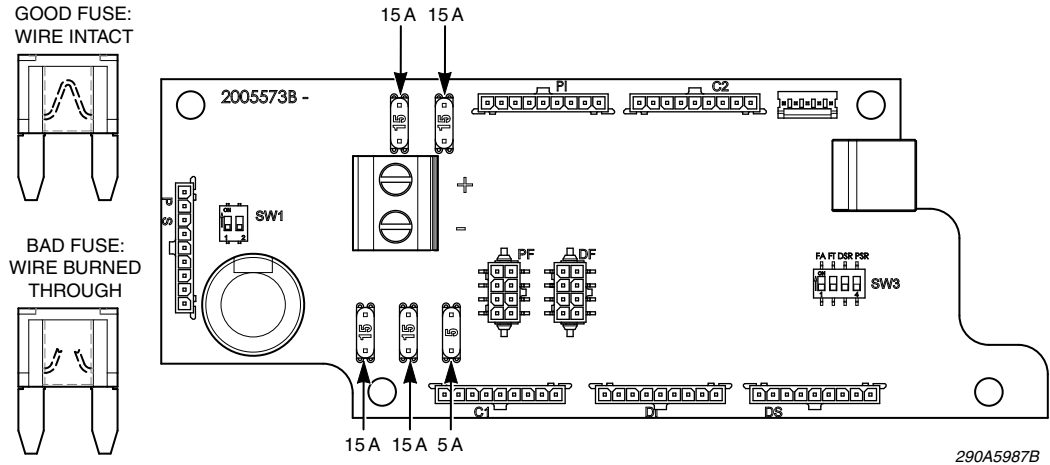

Reinstalling the Controller

To reinstall the controller:

1. Insert the four standoffs into the controller.
2. Gently push the controller's standoffs into their holes on the ROC panel until they lock.
3. Reconnect all wires and harnesses.
4. Turn the PCB over and place it on the two standoffs with the holes in the PCB centered over the holes in the standoffs. Ensure that the ground wire is not caught between the edges of the PCBs.
5. Gently push on the PCB until it clicks into place.
6. Turn the ROC panel over and connect the ground wire using the 1/4-inch hex bolt that you removed in step 2 in "Removing the Controller" on page 44
7. Place the dome over the PCB, ensuring that it is properly seated in the lip seal.
8. To prevent cross-threading, turn the barrel nuts counterclockwise until you hear a click, then tighten them. See Figure 14 on page 39.
9. Test the light bar to ensure that it operates properly.

Cleaning the Domes

Periodically cleaning the domes using proper procedures and compatible cleaners will prolong their service life. Unlike the reflectors, the domes do not have to be removed from the light bar for cleaning.

NOTICE

CRAZING/CLEANING SOLUTIONS: The use of cleaning solutions, such as strong detergents, solvents, and petroleum products, can cause crazing (cracking) of the light bar lens and reflectors. To clean the reflectors, use a soft, damp cloth. To clean the lens, use a soft cloth and a solution of water and a mild detergent.

⚠ WARNING

CRAZING/CHEMICALS: Crazed, cracked or faded lenses or reflectors reduce the light output and the effectiveness of the lighting system. A lens or reflectors showing this type of aging must be replaced. Failure to follow this warning may result in bodily injury or death.

To clean the domes:

1. Rinse the domes with lukewarm water to loosen dirt and debris.
2. Use a mild soap, lukewarm water, and a soft cloth to gently clean the plastic surfaces. To avoid damaging the reflectors, do not use heavy pressure or caustic, abrasive, or petroleum-based cleaners.
3. Rinse and dry the plastic surfaces with a soft cloth to prevent water spotting.

To remove fine scratches and haze, use a specialty plastic cleaner/polish and a soft cloth. You can also use a high quality automotive paste cleaner/wax that is non-abrasive.

Cleaning the Reflectors

Use a damp cloth to gently clean the plastic surfaces. To avoid damaging the reflectors, do not use heavy pressure or caustic, abrasive, or petroleum-based cleaners.

Troubleshooting the Light Bar

This section provides troubleshooting assistance for common problems. If you have any questions left unanswered, call the Federal Signal Service Department at 1-800-433-9132, 7 AM to 5 PM, Monday through Friday (CT).

Table 14 Troubleshooting tips

Problem	Corrective Action
The light bar does not light	<ul style="list-style-type: none"> • Check that the light bar's red power line (+BAT) and the black ground- power line (-GND) are properly connected to a good, fully charged 12-volt battery. • Ensure that the ground connection from the light bar controller to the aluminum extrusion is good. • Check that the CAT5 cable is connected to the Serial Interface Module (J1) and there are no damaged pins in the sockets. • Try a new CAT5 cable. • Check the connections on the Serial Interface Module: <ul style="list-style-type: none"> • the black wire and the black/white wire are connected to ground (-GND) • the white wire is connected to 12 Vdc • a MODE wire has 12 Vdc • Check the position of Switch 1 on SW-2 in the Serial Interface Module. If Switch 1 is down (ON), ensure that the ENABLE control wires (green/white and orange/black) have 12 Vdc applied. • Check the positions of the DIP switches in the Serial Interface Module. See Table 10 on page 21. • Check the fuses on the mainbar controller (Figure 19 on page 46).
An LED module does not light	<ul style="list-style-type: none"> • Swap the LED board with good board to see if the board is bad. • Check the connections of the cable that goes from the light bar controller to the LED ROC board. • Ensure that STEADY BURN switches on the light bar controller (SW3 PSR for the passenger side and SW3 DSR on the driver side) are set correctly (Figure 19 on page 45). • If it is a rear module, check the SignalMaster connections.
Half of an LED module does not light	Replace the ROC board that the LED is on.

Problem	Corrective Action
The light bar turns off when the FLASH TAKEDOWN/ALLEY lights turn on	<ul style="list-style-type: none"> • Ensure that the vehicle battery is fully charged. • Verify that the light bar's red power line (+BAT) and black ground-power line (–GND) are properly connected to a good, fully charged 12-volt battery. • Check the red power line (+BAT) and the black ground-power line (–GND) connections in the light bar and vehicle.
The light bar has a delayed response to being shut off	<ul style="list-style-type: none"> • Ensure that the connections on the Serial Interface Module are kept separate from strobe supplies. • Check all the ground connections, especially on the Serial Interface Module.
A FLASH TAKEDOWN/ALLEY light stays on with ignition power applied	<ul style="list-style-type: none"> • Ensure there is no voltage on the corresponding control wire. • To see if the ROC board is bad, swap it with a similar board. • Swap the cables on the light bar controller outputs with a known good output. If the problem moves to another takedown or alley light, send the light bar controller to Federal Signal for repair.
TAKEDOWN/ALLEY lights work, but FLASH TAKEDOWN/ALLEY lights do not work	<ul style="list-style-type: none"> • Ensure that 12 Vdc is applied to the TAKEDOWN and ALLEY (red/black) control wire. • Check the 12 Vdc power and negative ground connections to the light bar to ensure there is enough current.
Only one TAKEDOWN light turns on	Check the connections from the light bar controller to the ROC boards and ensure they are in the proper locations.
HotFoot TAKEDOWN/ALLEY lights flash with MODE, independent of FLASH TAKEDOWN/ALLEY input	Verify that the TAKEDOWN and ALLEY switches (SW3 FA and FT) are set in the ON position on the light bar controller (Figure 19 on page 46).
SignalMaster LEDs do not light	<ul style="list-style-type: none"> • Check the switch settings on the Serial Interface Module. Ensure they are set for the correct operation. See Table 10 on page 21. • Ensure that Switch 4 on SW-2 is in the correct position for the selected operation on the Serial Interface Module and ignition power was removed and reapplied. • Check the connections at the SignalMaster controller. If the controller is a model SS2000SM, ensure that the connector has power and the ground is connected to Pins 10 and 11 on the SignalMaster plug.

Getting Technical Support and Service

For technical support and service, please contact:

Service Department
Federal Signal Corporation
Phone: 1-800-433-9132
Email: empserviceinfo@fedsig.com
www.fedsig.com

Getting Repair Service

The Federal Signal factory provides technical assistance with any problems that cannot be handled locally.

Any units returned to Federal Signal for service, inspection, or repair must be accompanied by a Return Material Authorization (RMA). Obtain a RMA from a local Distributor or Manufacturer's Representative.

Provide a brief explanation of the service requested, or the nature of the malfunction.

Address all communications and shipments to the following:

Federal Signal Corporation
Service Department
2645 Federal Signal Drive
University Park, IL 60484-3167

Ordering Replacement Parts

To order replacement parts, call Customer Support at 1-800-264-3578, 7 a.m. to 5 p.m., Monday through Friday (CT) or contact your nearest distributor.

Table 15 Legend replacement parts

Description	Part Number
PCB Assembly, End (Configured)	Contact Federal Signal
PCB Assembly, Intermediate (Configured)	Contact Federal Signal
PCB Assembly, Center (Configured)	Contact Federal Signal
PCB Assembly, Controller (Configured)	Contact Federal Signal
PCB Assembly, Controller, Steady Burn Red, Driver Side (CA)	Contact Federal Signal
PCB Assembly, Controller, Steady Burn Red, Driver and Passenger Side (CA)	Contact Federal Signal
Fuse, Mini, Controller, 32 V, 15 A	148181-06
Fuse, Mini, 32 V, 5 A	148181-03
Fuse Holder, Maxi	143137
Fuse, Maxi, 20 A	148182-02
Fuse, Maxi, 40 A	148182-01
Gasket, End	8653110
Seal, Lip, Clear (5.5 ft per end section; 3.5 ft per center section)	8583020-01
O-Ring, Top Nut, 5/16-inch	7067016
Standoff, Nylon	230315
Base, End, Clear	8653100
Top, End, Clear	8653101
Top, End, Amber	8653101-02
Top, End, Blue	8653101-03
Top, End, Red	8653101-04
Base, Center, Clear	8653102
Top, Center, Clear	8653103
Top, Center, Amber	8653103-02
Top, Center, Blue	8653103-03
Top, Center, Red	8653103-04
Top, End, 12-inch, Clear (12-inch, 24-inch, and 32-inch models)	8653176
Top, End, 12-inch, Amber (12-inch, 24-inch, and 32-inch models)	8653176-02

Appendix A: Wiring Schematics

This section has schematics showing the Legend light bar with typical connections to these controllers:

- SignalMaster controller (external control)
- SW400SS Switch Module (internal control)
- SmartSiren Model SS2000SM
- Non-SignalMaster
- PA640

An Overview of the Discrete-Wired 24-inch Legend Light Bar

The Discrete-Wired 24-inch Legend is a special model that is designed to flash only one flash pattern as long as power is supplied to the light bar. Because the light bar does not connect to the Serial Interface Module, it has no CAT5 cable; the 10 AWG red and black cables are the only connections. An installer-supplied-switch is required. See schematic A 1.

Schematic A 1 Discrete-wired 24-inch Legend light bar

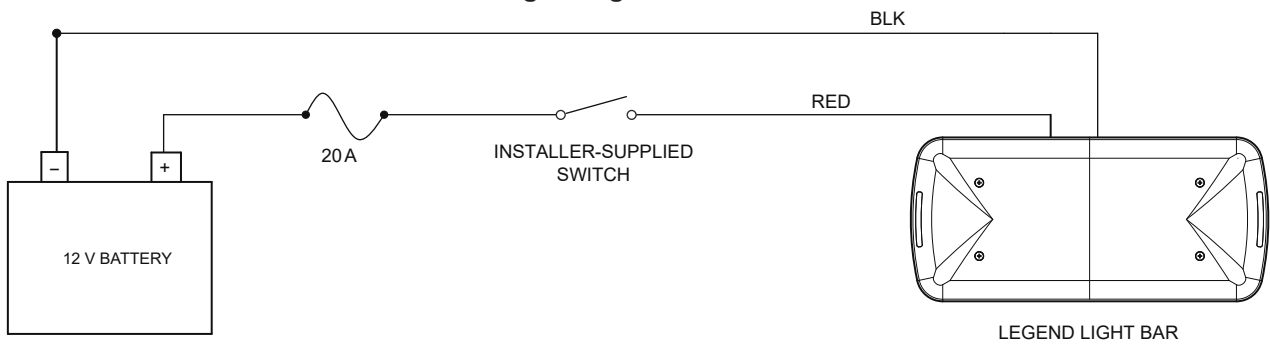

290A6306

Schematic A 2 Typical connections with a SignalMaster controller (External control)

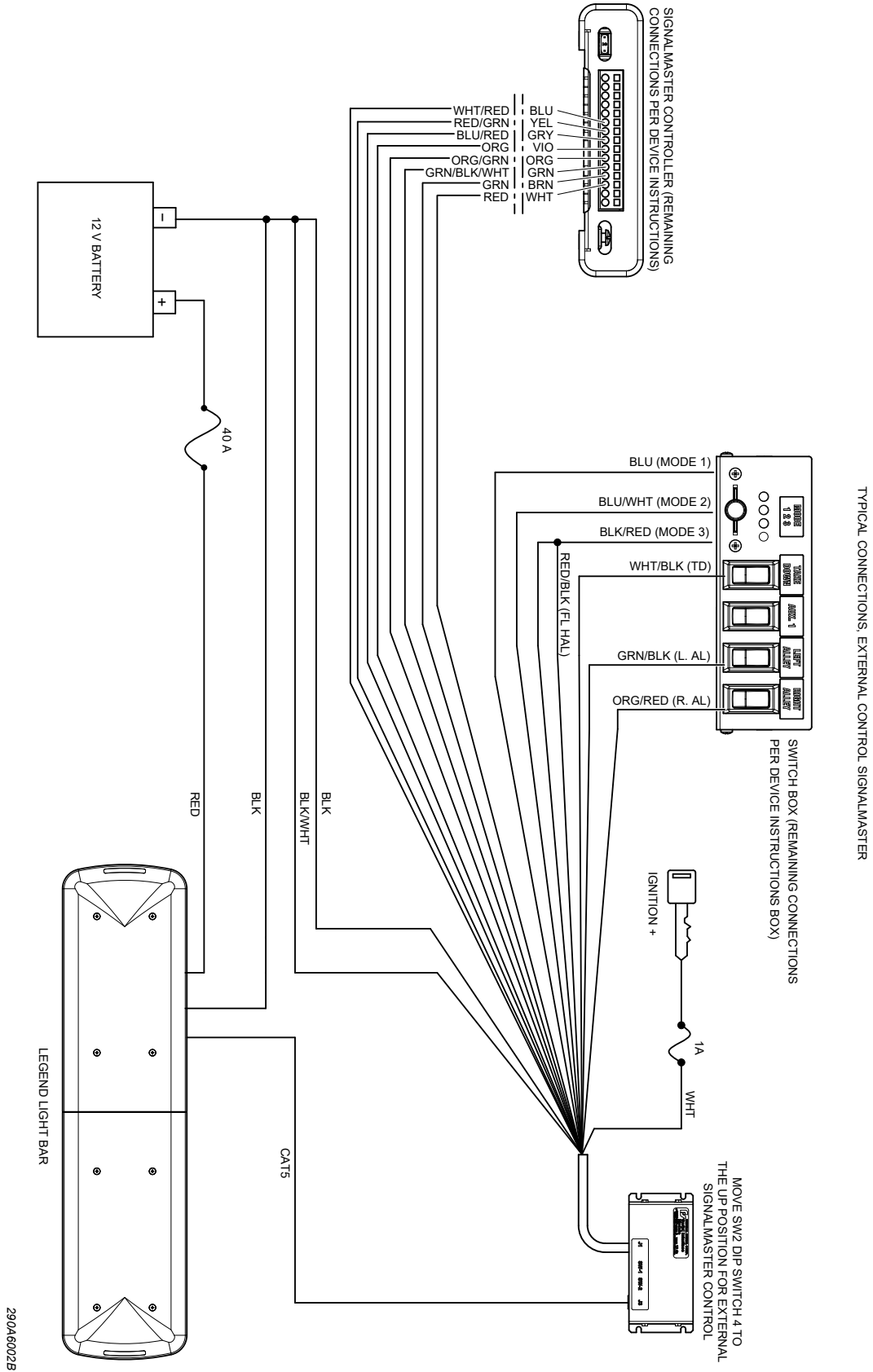

Schematic A 3 Typical connections with a SW400SS Switch Module (Internal control)

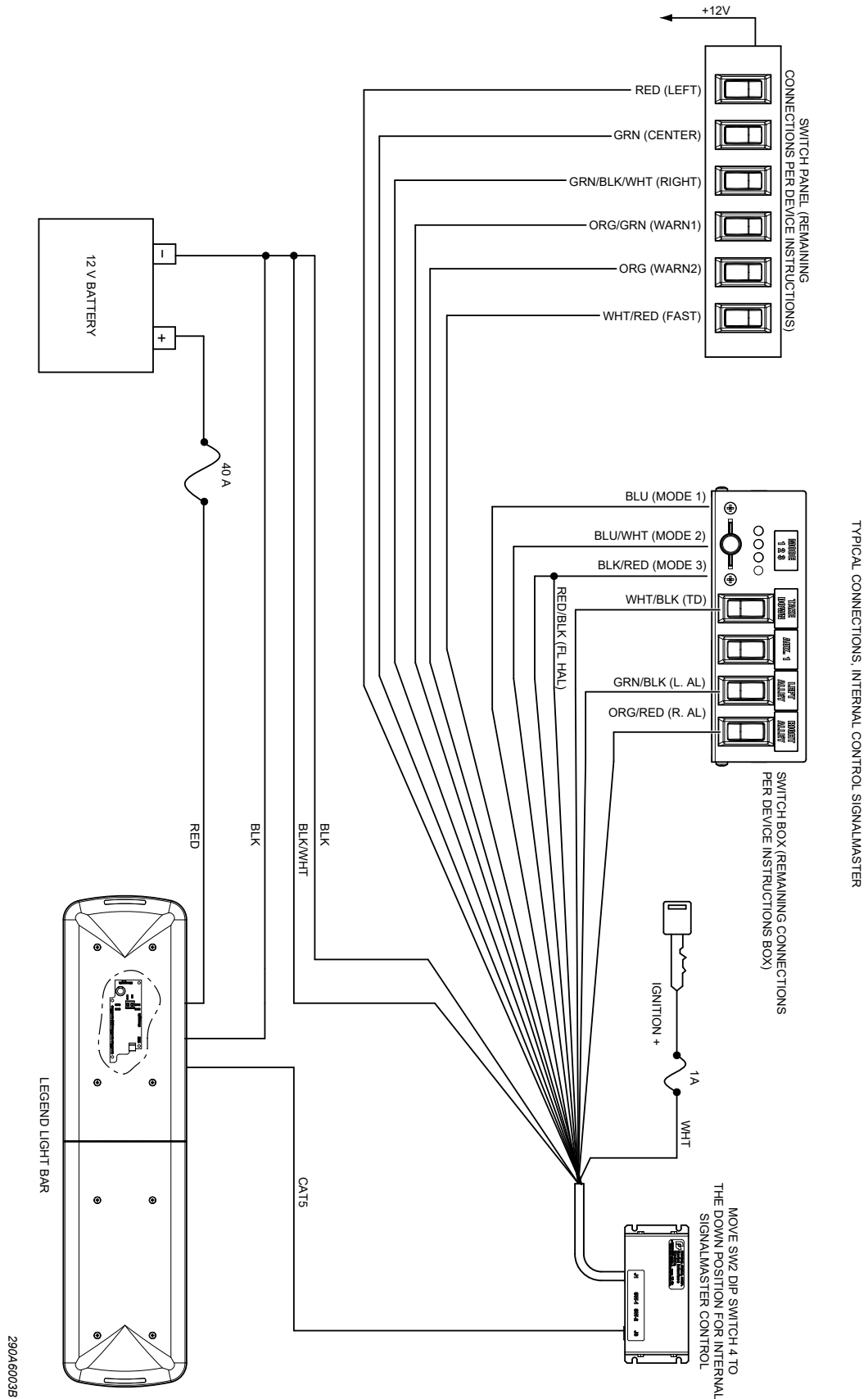

Schematic A 4 Typical connections with a SmartSiren controller

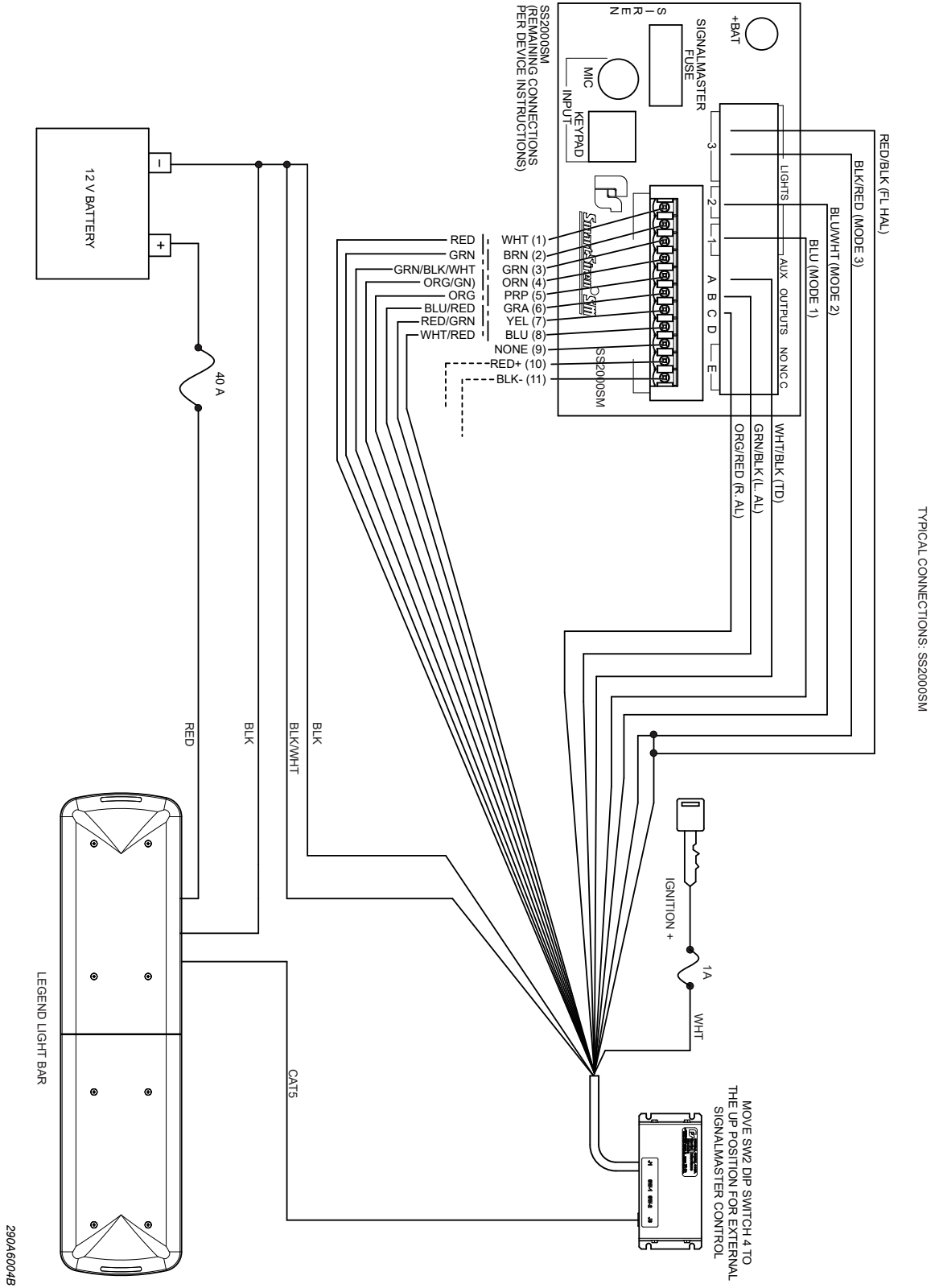

Schematic A 5 Typical connections with a non-SignalMaster controller

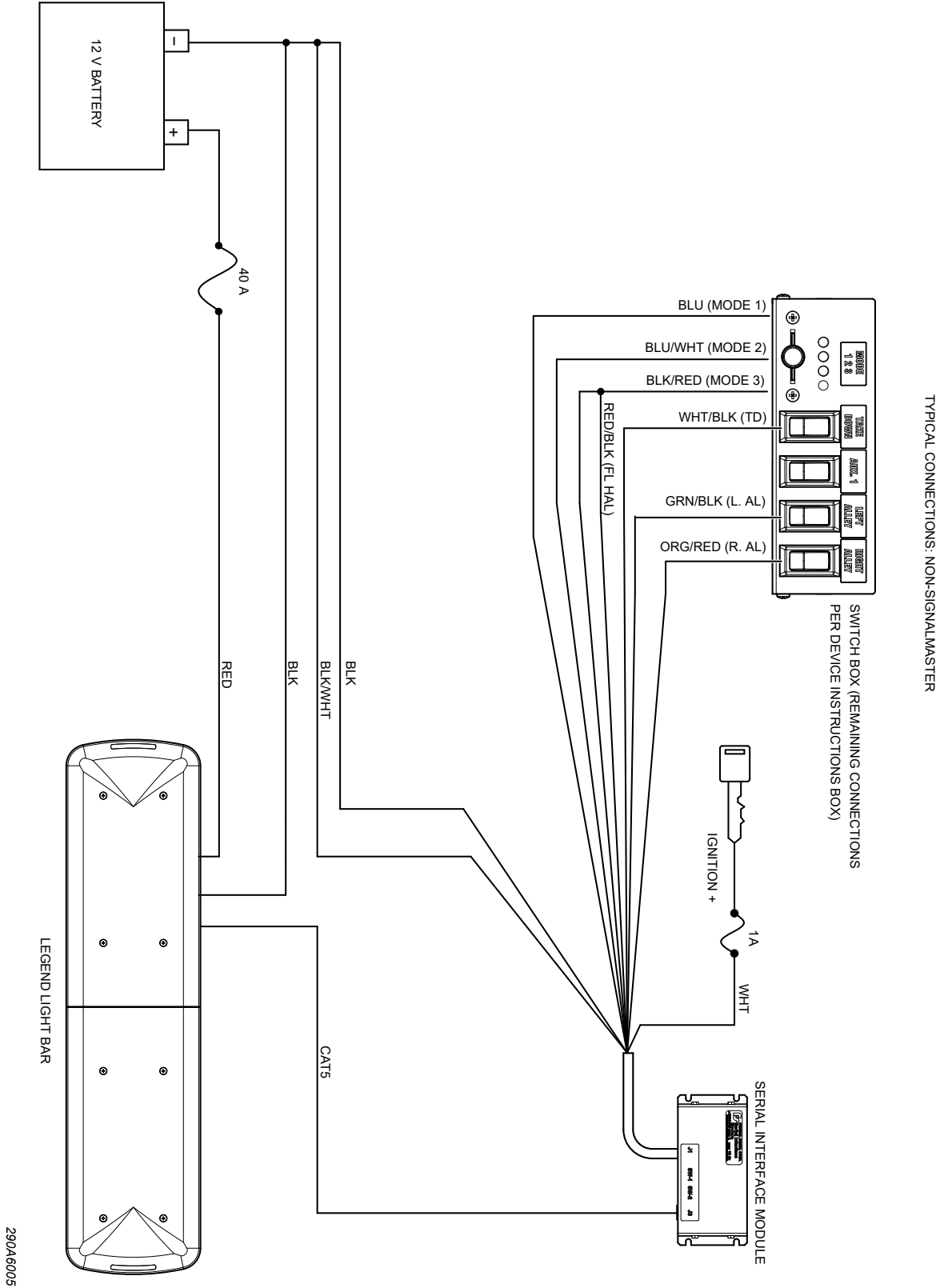

Schematic A 6 Typical connections with a PA640 controller

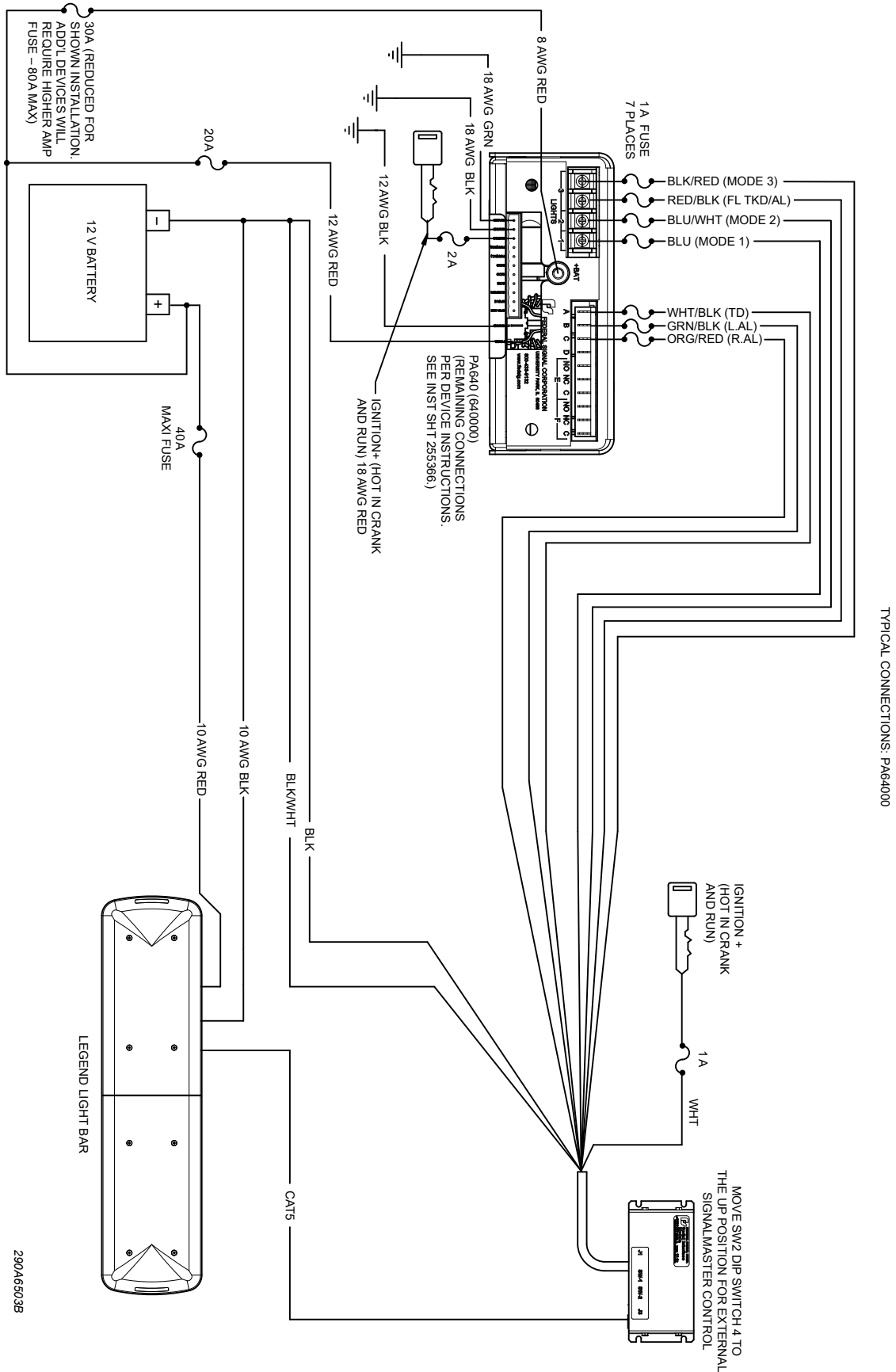

Schematic A 7 Typical connections for LPXD Discrete Legend and LPX Legend

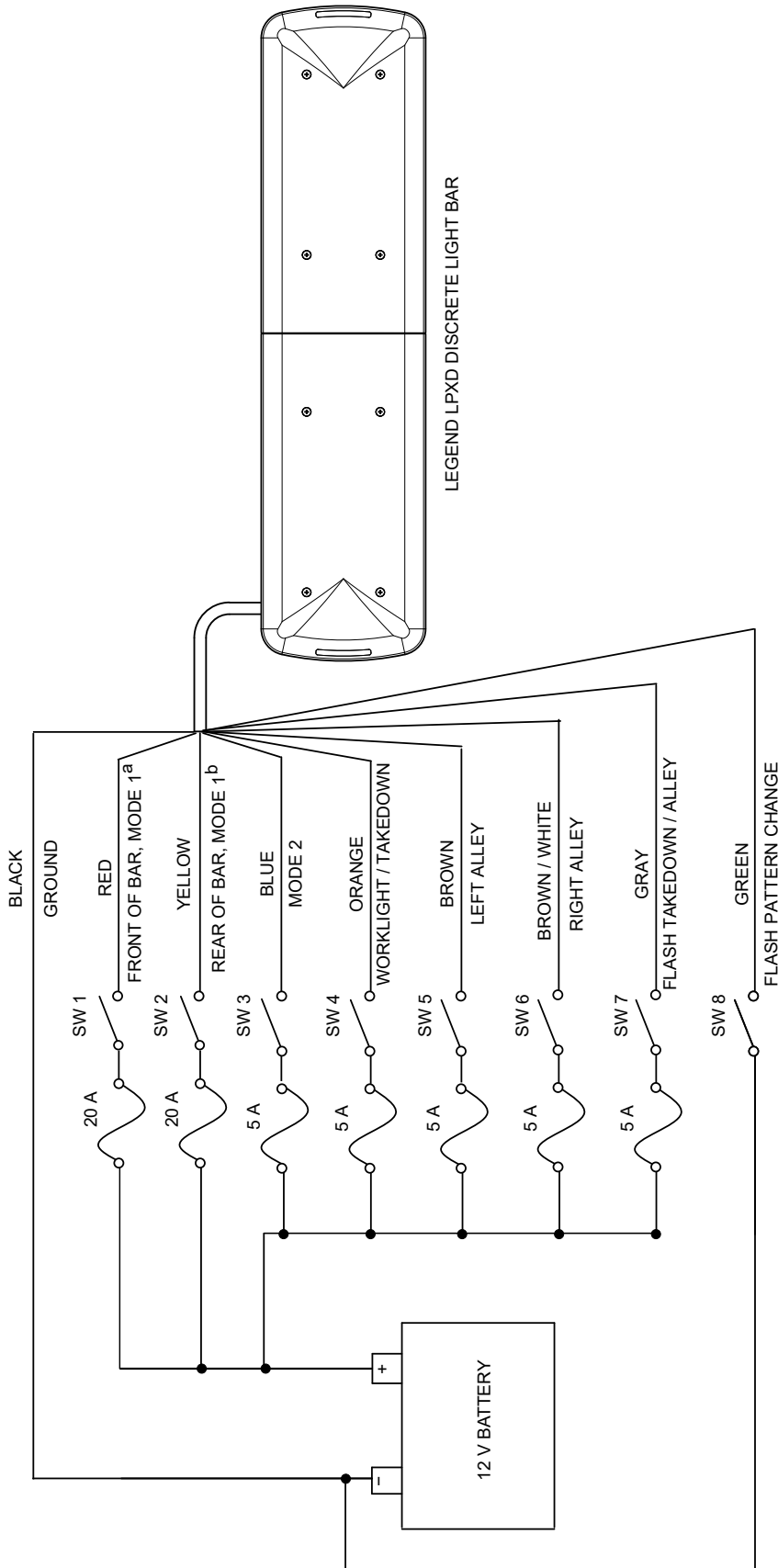

^a ACTIVATE MODE 1 ALONE FOR REAR CUTOFF

^b ACTIVATE MODE 1 ALONE FOR FRONT CUTOFF

290A7002C

Schematic A 8 Typical connections for LPXD Discrete Legend and LPX Legend with Preterminated Weather tight Connectors

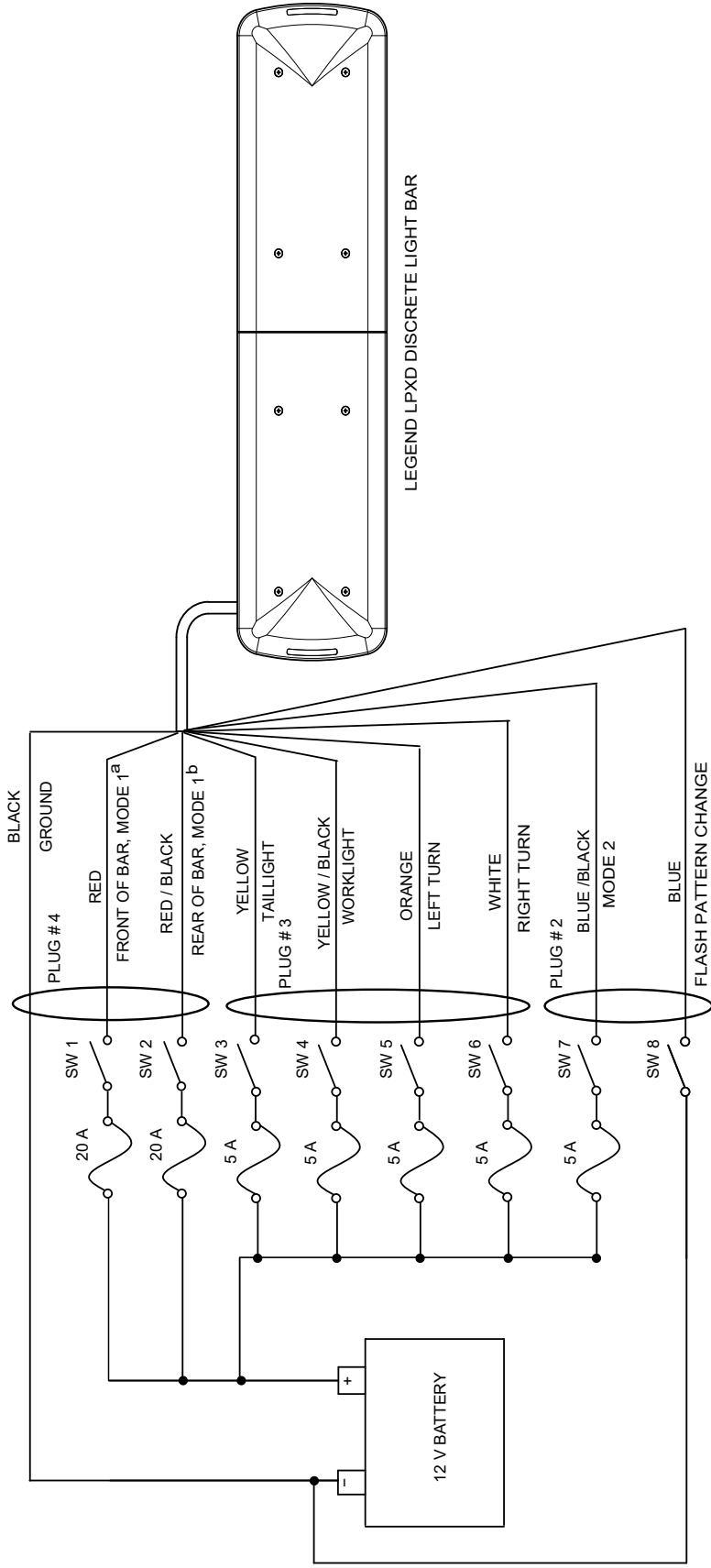

^a ACTIVATE MODE 1 ALONE FOR REAR CUTOFF

^b ACTIVATE MODE 1 ALONE FOR FRONT CUTOFF



FEDERAL SIGNAL
Safety and Security Systems

2645 Federal Signal Drive
University Park, Illinois 60484-3167

www.fedsig.com

Customer Support

Police/Fire-EMS: 800-264-3578 • +1 708 534-3400

Work Truck: 800-824-0254 • +1 708 534-3400

Technical Support 800-433-9132 • +1 708 534-3400