

Pathfinder®

Siren and Light Controller



FEATURES

- 100/200 W siren and light controller with PA and noise-canceling microphone
- Built-in dual-tone capability when used with (2) speakers
- Built-in Rumbler® traffic clearing capability
- Optional FS Vehicle Integration/On-Board Diagnostics (OBDII)
- Programmable timer feature
- Siren tones, PA, Radio Rebroadcast and Air Horn
- Library of selectable siren tones includes SmartSiren®, Unitrol™, and Powercall siren tones
- Horn Ring Transfer and Park Kill
- Backlit LEDs on control faceplate emulate SignalMaster™ directional warning operation
- (7) programmable inputs and (12) programmable solid-state relay outputs
- Convergence Network Configuration Software allows for easy customization of siren and light controls
- (2) FS Convergence Network ports
- Standard voice messages available in English, Spanish and French Canadian to broadcast alerts. Custom voice messages available for an additional fee
- Five-year warranty

APPROVALS

- SAE J1849
- CCR Title 13
- NFPA 1901

FS TECHNOLOGIES



Pathfinder® is a compact, programmable siren and light controller available with self-contained controls, remote surface-mount control heads, or handheld control head. Pathfinder is packed with features such as dual-tone and integrated Rumbler traffic clearing capability along with optional Federal Signal Vehicle Integration/On-Board Diagnostics (OBDII) integration. Pathfinder is easy to install and incorporates Convergence Network Configuration Software to provide a high-level of customizable control capability. Convergence Network Configuration Software is available as a download from the Federal Signal website making it easy to program one vehicle – or an entire fleet – from your laptop.

Controller Features

Pathfinder provides the user with customized control of the siren, warning lights, directional lights, and other accessories. Pathfinder can control the SignalMaster™ directional functions in light bars, ILS systems and “stick” lights that are compatible with FS Convergence Network as well as Latitude™ 3-wire SignalMaster. For convenient visual reference, the Pathfinder emulates the selected pattern of the SignalMaster operation.



All controller options feature programmable buttons that can be programmed for press-on, press-off, momentary, and multiple different blinking styles. The button brightness can be dimmed or turned-off for stealth operation. Over (100) labeling stickers, such as alley, gun lock, and wail allow for further customization of the control head.

Button color can be programmed through the Convergence Network Configuration Software. The self-contained and remote models can be programmed in dual color (Red/Blue) while the Handheld, 17-button, 6-button and 4-button can be programmed in nine different colors - Red, Blue, Green, Cyan, Magenta, Yellow, White, Purple and Amber.





Pathfinder® MODELS

PF200

Self-Contained Controls with Rotary Knob and Slide Switch



PF200H

Hand-held Controller / Microphone with (14) buttons



PF2004S

Remote Surface-mount Controller with (4) buttons



PF200R

Remote Surface-mount Controller with Rotary Knob and Slide Switch



PF200S17B

Remote Surface-mount Controller with (17) buttons and Slide Switch



PF200S6

Remote Surface-mount Controller with (6) buttons and Slide Switch



CONTROLLERS OPTIONS



Self-Contained Controls and Remote Surface-Mount Controller

The control faceplate includes a four-position progressive slide switch, seven-position rotary switch and (9) backlit buttons. The noise-canceling microphone that is included with the remote-control head uses a RJ11 connector to plug directly into the control head, eliminating the need to run a mic cable back to the amplifier. For increased versatility the amplifier offers a ¼-inch jack microphone plug option (¼-inch jack microphone and remote extension kit sold separately).

Hand-Held Controller

The hand-held controller features (14) backlit buttons, and the ergonomic design provides convenient volume control and push-to-talk button on the side of the controller. It also has a magnetic mount and includes brackets for fixed or swivel mounting. The microphone is included in the control head, eliminating the need to run a mic cable back to the amplifier. For increased versatility, the amplifier offers a ¼-inch jack microphone plug option. (¼-inch jack microphone and remote extension kit sold separately).



17-Button Controller

The 17-button controller features a four-position progressive slide switch and (17) backlit buttons. For visual reference, the control head emulates the selected pattern of the SignalMaster operation. The included noise-canceling microphone uses a RJ11 connector to plug directly into the control head, eliminating the need to run a mic cable back to the amplifier. For increased versatility, the amplifier offers a ¼-inch jack microphone plug option (¼-inch microphone and remote extension kit sold separately)



4-Button Controller

The 4-Button controller faceplate includes (4) backlit buttons. For visual reference, the control head emulates the selected pattern of the SignalMaster operation. The noise-canceling microphone that is included with the PF200S4 uses a ¼-inch jack plug that plugs directly into the amplifier. A remote extension kit is included.



6-Button Controller

The 6-Button controller faceplate includes (6) backlit buttons and a four-position progressive slide switch. For visual reference, the control head emulates the selected pattern of the SignalMaster operation. The noise-canceling microphone that is included with the PF200S6 uses a ¼-inch jack plug that plugs directly into the amplifier. A remote extension kit is included.

Amplifier Features

Pathfinder default siren tones include Wail, Yelp, Priority, Manual/Peak-and-Hold, Hi-Lo, Powercall, and Air Horn. A library of other selectable siren tones are available including Unitrol™ branded siren tones such as Wail, Yelp, Futura, Hi-Lo, Ultra Hi-Lo, Alarm, Air Horn, and Hetro. PA, radio rebroadcast, and Air Horn are standard in the Pathfinder. Pathfinder also includes (2) serial ports to be used with the FS Convergence Network devices such as light bars or directional warning lights for easy “plug-n-play” installation.

Other amplifier features include horn ring transfer (TAPII, Timer or Hands Free), Park, Ignition, and (4) general purpose inputs for trunk/door release, gun lock, intrusion alarms and monitoring K9 temperature systems. The polarity of each input is programmable except for ignition.

Timer Feature

The Pathfinder built-in timer feature senses ignition ON/OFF and allows the selection of multiple time settings. Various devices can be wired to relay outputs on the Pathfinder amplifier (such as in-car video DVRs, radios, and laptop chargers), and a security shotgun timer is provided to minimize the possibility of unauthorized shotgun release. Pathfinder timer feature allows the end user to avoid the extra cost of an external timer per vehicle by allowing each device to be turned off at a different time, unlike many one setting external timers used by departments.

Integrated Rumbler® Capability

The Pathfinder is available with built-in Rumbler Traffic Clearing capability. This allows the Pathfinder to produce a Rumbler tone without the need for a separate externally mounted amplifier. Rumbler capability requires the purchase of Rumbler woofers and vehicle specific mounting kit. Dual-tone capability cannot be utilized with the Rumbler capability unless a complete RUMBLER-3, which includes the additional amplifier, is purchased.

- Pathfinder + (1) 100 W siren speaker = Single tone and standard PA
- Pathfinder + (2) 100 W siren speakers = Dual-tone and standard PA
- Pathfinder + (1) 100 W speaker + (1) or (2) Rumbler woofers = Single tone, Rumbler and enhanced PA
- Pathfinder + (2) 100 W siren speakers + RUMBLER-3 kit (includes two woofers) = Rumbler, Dual-tone siren, and standard PA (one channel will Rumble)
- Pathfinder + (1) or (2) Rumbler woofers + (2) 100 W siren speakers + MS4000 = Dual-tone, Rumbler, and enhanced PA



Steady Burn Models

Exterior lights are available as steady burn models for use with the Pathfinder siren. The combination of Steady Burn models and the Pathfinder siren allows the Pathfinder to control lights around the vehicle by utilizing flash patterns in the siren, syncing/alternating light heads, and dimming light heads.



FS Vehicle Integration/On-Board Diagnostics Integration (OBDII)

The FS Vehicle Integration is a simple plug-in connection using the existing vehicle CAN bus system. The FS Vehicle Integration uses a vehicle specific cable (sold separately) to seamlessly integrate with the vehicle allowing light and siren control with vehicle events such as door open, headlight, brake, speed, park, etc. The use of the FS Vehicle Integration removes the need to separately wire certain options such as horn ring transfer or ignition.

For a full list of vehicles, please visit www.fedsig.com.



Programming Software Features

The Convergence Network Configuration Software is available as a download from the FS website and siren configurations can be created via laptop computer. Configured programs can be extracted, modified, and stored for ease of service and re-use. The Federal Signal Convergence Network allows the user to "plug-n-play" simply by connecting the siren to the vehicle's light bar. Pathfinder gives the user the ability to clone an entire fleet of siren functions. The user simply connects the Pathfinder to a PC and downloads the functions of the programmed software onto a USB drive to download functions to each siren.



Rear Expansion Module

The EXPMOD-2 Rear Expansion Module works with any Pathfinder Siren to provide an additional (16) 7.5 Amp flashing outputs and (2) 20 Amp control outputs. The Rear Expansion Module makes installation faster and easier by giving you full control of OEM brake, tail, turn, reverse and third brake light lighting without the use of additional flashers. (9) blackout relays are also included that allow trained officers to have the ability to cut off all rear lighting to avoid detection. The Rear Expansion Module includes (3) serial ports to be used with the FS Convergence Network devices such as light bars or directional warning lights for easy "plug-n-play" installation.



The Rear Expansion Module is controlled by a Pathfinder siren that can be programmed through the Convergence Network Configuration Software to provide a high-level of distributed and customizable control capability. Up to two Rear Expansion Modules can be used with a Pathfinder Siren providing a total of (32) 7.5 Amp flashing outputs and (4) 20 Amp control outputs. Vehicle specific rear taillight connection wire harnesses are available for the Dodge Charger Pursuit, Chevrolet Tahoe, Dodge Durango, and Ford Police Interceptor Utility.

24-Channel Expansion Module

The EXPMOD24 24-Channel Expansion module works with any Pathfinder Siren to provide an additional 24 flashing outputs to a Pathfinder System. The 24-Channel Expansion Module is controlled by a Pathfinder siren that can be programmed through the Convergence Network Configuration Software to provide a high-level of distributed and customizable control capability. The maximum output current for each relay can also be set with the Convergence Network Configuration Software. The 24-Channel Expansion Module is potted to help protect it from unfavorable weather conditions making it ideal for under the hood mounting. Up to four 24-Channel Expansion Modules can be used with a Pathfinder siren.



Power Distribution Module

The PFPDM-1 Power Distribution Module provides electrical power from one main power source. The Power Distribution Module makes installation faster and easier and increases reliability due to having fewer failure points. In the case of a product losing power, the Power Distribution Module features diagnostic LEDs that will allow the failure point to be quickly located. The Power Distribution Module includes (4) serial ports to be used with the FS Convergence Network devices, such as light bars or directional warning lights, for easy "plug-n-play" installation. The Power Distribution Module also includes (4) programmable outputs that can be programmed through the Convergence Network Configuration Software to provide a high-level of distributed and customizable control capability.



On Scene Sync Module

The PFSYNC-1 On Scene Sync Module works in conjunction with any Pathfinder Siren to provide synchronization between multiple "like-programmed" vehicles. On Scene Sync Module uses a GPS signal to maintain timing between vehicles providing the capability to synchronize warning lights, and voice messages to unify the visual and audible warning of multi-vehicle response. An ambient light sensor is also included in the On Scene Sync Module to auto adjust warning lights.



HOW TO ORDER

PF200S6	Siren/Light Controller with 6 button controller, 100/200 W, OBDII integration capability, integrated Rumbler capability and Integrated dual-tone capability	OBDCABLE8-GMCAN	8-ft OBDII interface cable, for use on 2021-2022 Chevrolet Tahoe
PF200S4	Siren/Light Controller with 4 button controller, 100/200 W, OBDII integration capability, Integrated Rumbler capability and integrated dual-tone capability	OBDCABLE8-4	8-ft OBDII interface cable, for use on 2021-2022 Ford Mustang Mach-E and 2022 Ford F-150 Lightning
PF200	Siren/Light Controller with self-contained controls, 100/200 W, OBDII integration capability, integrated Rumbler capability, and integrated dual-tone capability	OBDCABLE20-GMCAN	20-ft OBDII interface cable, for use on 2021-2022 Chevrolet Tahoe
PF200R	Siren/Light Controller with Remote surface mount controller, 100/200 W, OBDII integration capability, integrated Rumbler capability, and integrated dual-tone capability	OBDCABLE20-4	20-ft OBDII interface cable, for use on 2021-2022 Ford Mustang Mach-E and 2022 Ford F-150 Lightning
PF200H	Siren/Light controller with hand-held controller/microphone, 100/200W, OBDII integration capability, integrated Rumbler capability, and integrated dual-tone capability	OBDCABLE25-DGCAN	25-ft OBDII interface cable, for use on 2018-2022 Dodge Charger Pursuit and 2018-2022 Dodge Durango, and 2018-2022 Dodge Ram 1500
PF200S17B	Siren/Light Controller with 17 button controller, 100/200 W, OBDII integration capability, integrated Rumbler capability, and integrated dual-tone capability	MNCT-SD	¼-in Jack microphone
PF200AMP	Pathfinder Amplifier, no controller	RMK	Remote extension kit for ¼-in jack microphone
PF100	Siren/Light Controller with self-contained controls	RBKIT1*	Single Rumbler woofer
PF100H	100 W, OBDII integration capability Siren/Light Controller with hand-held controller/microphone, 100 W, OBDII integration	RBKIT2*	Pair of Rumbler woofers
		PFPDM-1	Power Distribution Module, 100 A max load
		PFSPLTR-4	4-to-1 splitter
		PFSYNC-1	On Scene Sync Module
		EXPMOD24	24-Channel Expansion Module
		EXPMOD-2	Rear Expansion Module, (18) solid state programmable relay outputs, (16) 7.5 Amp flashing outputs and (2) 20 Amp control outputs
		EXPHARN01	Rear taillight connection wire harness for use with EXPMOD-2 expansion module, Dodge Charger Pursuit, 2015-2022
		EXPHARN03	Rear taillight connection wire harness for use with EXPMOD-2 expansion module, Ford Interceptor Utility 2020-2022
		EXPHARN04	Rear taillight and rear liftgate lighting connection wire harness for use with EXPMOD-2 expansion module, Dodge Durango, 2018-2022
		EXPHARN05	Rear taillight connection wire harness for use with EXPMOD-2 expansion module, Chevrolet Tahoe, 2021-2022

ACCESSORIES

PF-VM	1-3 custom messages, one-time set up fee
RUMBLER-3	Siren Amp, Rumbler, secondary warning system, 12 Vdc, low frequency tones, hardware kit, housing bands and cradles. Used with PF200 to utilize dual-tone and Rumbler capabilities
OBDCABLE6-1	6-ft OBDII interface cable, for use on 2018-2020 Chevrolet Tahoe, 2013-2019 Ford Police Interceptor Utility, 2018-2019 Ford F-150, 2018-2021 Chevrolet Silverado
OBDCABLE6-2	6-ft OBDII interface cable, for use on 2020-2022 Ford Police Interceptor Utility
OBDCABLE6-3	6-ft OBDII interface cable, for use on 2020-2021 Ford Expedition, 2020 Ford F-150, and 2020-2022 Ford F-250/F-350/F-450/F-550 (Models equipped with 4" or 8" entertainment screen only)
OBDCABLE25-3	25-ft OBDII interface cable, for use on 2020-2021 Ford Expedition, 2020 Ford F-150, and 2020-2022 Ford F-250/F-350/F-450/F-550 (Models equipped with 4" or 8" entertainment screen only)
OBDCABLE25-1	25-ft OBDII interface cable, for use on 2018-2020 Chevrolet Tahoe, 2013-2019 Ford Police Interceptor Utility, 2018-2019 Ford F-150, 2018-2021 Chevrolet Silverado
OBDCABLE25-2	25-ft OBDII interface cable, for use on 2020-2022 Ford Police Interceptor Utility
OBDCABLE6-DGCAN	6-ft OBDII interface cable, for use on 2018-2022 Dodge Charger Pursuit and 2018-2022 Dodge Durango, and 2018-2022 Dodge Ram 1500

***VEHICLE SPECIFIC RUMBLER BRACKETS SOLD SEPARATELY**

STEADY BURN MODELS

MICROPULSE WIDE ANGLE STEADY BURN MODELS

MPSW9X-BW	(12) LEDs, light head, Blue/White
MPSW9X-RW	(12) LEDs, light head, Red/White

416900XZ CORNER LEDS STEADY BURN MODELS

416900XZ-BW	Dual-color Corner LED with in-line flasher, Steady burn, Blue/White
416900XZ-RW	Dual-color Corner LED with in-line flasher, Steady burn, Red/White

416300 STEADY BURN MODELS

416300X-B	(3) LEDs, Steady burn, Blue
416300X-R	(3) LEDs, Steady burn, Red
416300X-BW	(6) LEDs, Steady burn, Blue/White
416300X-RW	(6) LEDs, Steady burn, Red/White
416300X-RB	(6) LEDs, Steady burn, Blue/Red

SPECIFICATIONS

	PATHFINDER 100 W	PATHFINDER 200 W
AUDIO OUTPUT POWER	100 W	200 W
INPUT VOLTAGE	11/28 Vdc	11/28 Vdc
NOMINAL OUTPUT VOLTAGE	64 V peak-to-peak	64 V peak-to-peak
STANDBY CURRENT	< 0.1 A	< 0.1 A
INPUT CURRENT, OPERATING	8 A	16 A
OPERATING TEMP	-40° to +176° F [-40° to +80°C]	-40° to +176° F [-40° to +80°C]
POLARITY	Negative ground only	Negative ground only
FREQUENCY RANGE	182 to 1600 Hz	182 to 1600 Hz

AMPLIFIER PHYSICAL SPECIFICATIONS

	PF200	PF200R	PF200H	PF200S17B	PF200S6	PF200S4
HEIGHT	2.5 in (6.4 cm)	2.5 in (6.4 cm)	2.5 in (6.4 cm)	2.5 in (6.4 cm)	2.5 in (6.4 cm)	2.5 in (6.4 cm)
WIDTH	6.0 in (15.2 cm)	6.0 in (15.2 cm)	6.0 in (15.2 cm)	6.0 in (15.2 cm)	6.0 in (15.2 cm)	6.0 in (15.2 cm)
LENGTH	7.0 in (17.8 cm)	7.0 in (17.8 cm)	7.0 in (17.8 cm)	7.0 in (17.8 cm)	7.0 in (17.8 cm)	7.0 in (17.8 cm)

CONTROL HEAD PHYSICAL SPECIFICATIONS

	PF200	PF200R	PF200H	PF200S17B	PF200S6	PF200S4
HEIGHT	2.5 in (6.4 cm)	2.5 in (6.4 cm)	6.0 in (15.2 cm)	3.3 in (8.4 cm)	2.8 in (7.1 cm)	1.6 in (4.1 cm)
WIDTH	6.0 in (15.2 cm)	6.0 in (15.2 cm)	2.5 in (6.4 cm)	6.8 in (17.3 cm)	2.6 in (6.6 cm)	3.5 in (8.9 cm)
LENGTH	8.4 in (21.3 cm)	1.5 in (3.5 cm)	1.3 in (3.3 cm)	1.4 in (3.6 cm)	1.1 in (2.8 cm)	1.0 in (2.5 cm)

SHIP WEIGHT

	4.7 lb (2.1 kg)	6.0 lb (2.7 kg)	5.0 lb (2.3 kg)	6.0 lb (2.7 kg)	5.9 lb (2.7 kg)	5.9 lb (2.7 kg)
--	-----------------	-----------------	-----------------	-----------------	-----------------	-----------------

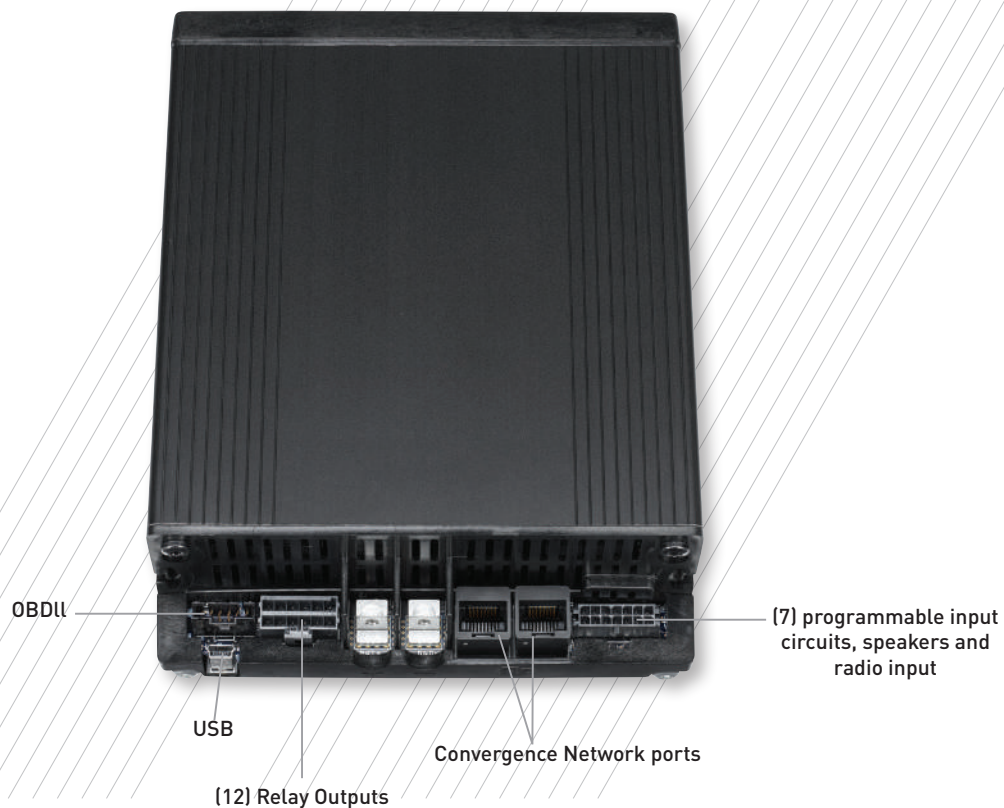
Top View of PF200

PATHFINDER DIMENSIONS

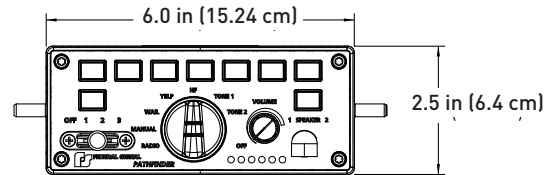
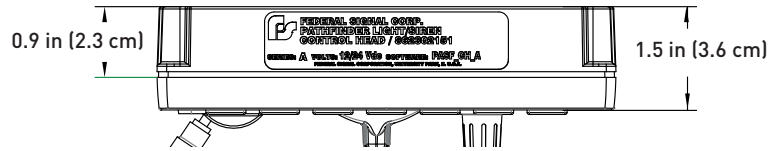
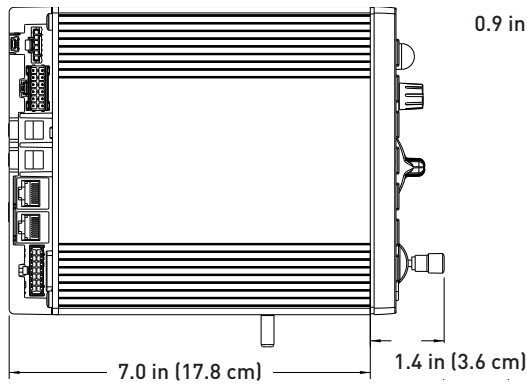

4-BUTTON CONTROLLER

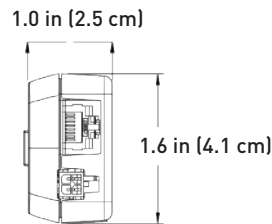
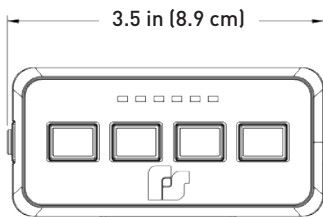

HAND-HELD CONTROLLER

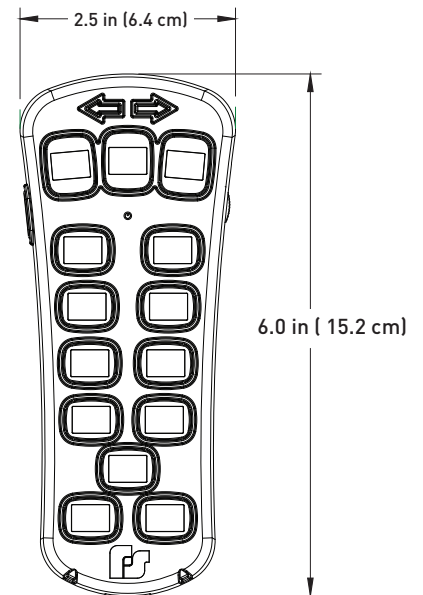

6-BUTTON CONTROLLER

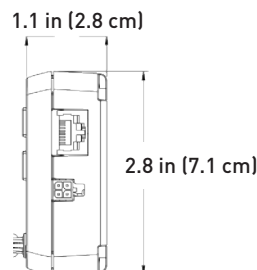
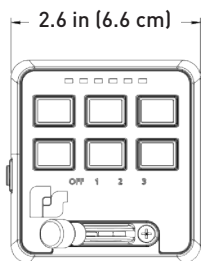

17-BUTTON CONTROLLER

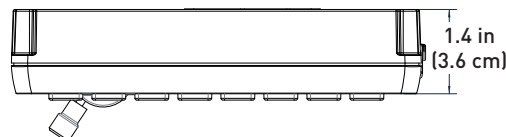
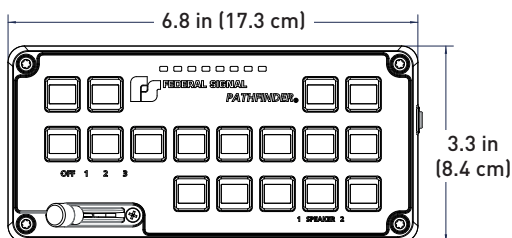

Pathfinder, Rumbler, Unitrol, Latitude and SignalMaster are registered trademarks of Federal Signal Corporation. Ford, Chevrolet, and Dodge are all trademarks of their respective owners.

Warning: Sirens and Speakers may produce LOUD sounds necessary to request the right-of-way. Sirens and Speakers may cause hearing damage. Wear hearing protection.